

Dreaming the

PYRAMID



*The premise is simple, the implications, extraordinary:
Egypt's Great Pyramid, the Last Remaining Wonder of the
Ancient World, was designed and built to represent the
greatest wonder of all...US!*

STEPHANE WUTTUNEE

DREAMING THE PYRAMID is released as a free E-Book for downloading and redistribution with the following conditions:

- That it remain unmodified and in its original state.
- That it remain free. It may not be sold by anyone for any purpose. However, it may be included as part of "bundle packages" with other materials as long as it does not add to the cost of the original materials/package bundle.

CONTENTS

INTRODUCTION_____ 7

THE PRIMER_____ 19

Space: Home to Neighbors Near and Far. The
Miracle of Romance and Love. A Question of Shut
Eye. The Quest for Eternal Youth. Why Two
Genders? Are Humans Alien to Earth? Creation:
A Process in Evolution. New Beginnings.

THE CIRCLE_____ 57

What is the Light? The Decision to Create.
A Binary Solar System. War in the Heavens. Our
Earthly Laboratory and Playground. Third Eye.
An Unencumbered Paradise. Star Travel.

EROTIC SOUL EXPRESSION_____ 87

Reason for the Fall. The Gender Split. The
Soulmate Shuffle. Our Eternal Ties. The Passion
Fruit. The Rainbow Serpent. Love's AC/DC Nature.

AFTER THE FALL_____ 117

The Rise of Civilizations. Wrath of Gaia. The Forgotten
Nightmare. The Earth Way: An Indigenous
Perspective. Choosing the Path. Telling it like it is.

EGYPT'S GREAT PYRAMID_____ 143

Language of the Stars. The Astrological Pyramid.
The Thirteenth Sign. More Surprises Unsealed. The
Kundalini.

CRYSTAL SECRETS_____ 180

Our Crystal Powers. An Identical Twin. Romance
in the Pyramid. The Numbers of Love.

π_____ 219

22 - Solar Spirit. 7 - Our Crystallized Mother
Earth. 3 - The Christ Child. 142857 - An Immortal
Flesh Organism.

REVELATION 666_____ 259

The Dark Side goes Digital. Humans and
Computers: Their Striking Similarities.

ALIENS AND UFOS_____ 297

What are UFO Abductions? Ezekiel's Vision. No

Need to Run.

CONCLUSION_____ 342

APPENDICE 1: THE GREATEST HURDLE_____ 354

APPENDICE 2: AN OVERVIEW OF GREAT PYRAMID

TEACHINGS _____ 367

APPENDICE 3: DREAM LOG_____ 383

The Frogman and a Ship lost at Sea. The Sasquatch
and the Strange House. The Owl and the Crystal
Pyramid. The Twelve Hour Watch Piece. A Lion in the
White House. The Snake and the River. A Parade of
the Feminine. Dad's Dream.

RECOMMENDED READING_____ 414

Teach traditional things and be respected.

Teach interesting things and be in demand.

Teach incredible things and risk ridicule.

INTRODUCTION

The great secrets of the world are not ones kept from us. Rather, due to the fear of change and accountability, they are ones we keep from ourselves.

The challenge presented here then holds no illusions. What is about to be attempted can only be described as the impossible - especially on the scale and magnitude I am aiming for. This book's mission is to help us remember how and why we played a role in helping God engineer and build the Universe, the Earth, even life itself. In these pages I will also show in explicit detail how Egypt's Great Pyramid

represents us as immortal, omniscient, and androgynous beings. The Great Pyramid is the perfect human body encased in stone.

Your eyes are not deceiving you. You read that right. I am stating that we co-created everything (and everywhere) and that the Pyramid has, until now, successfully kept its greatest secret "secret".

My name is Stephane Wuttunee. I am French Canadian and Plains Cree from the Canadian western plains. Though many books about my people and our philosophies exist, this book greatly differs from others in both its style and message.

For one, this book is not about "Indians" or Native culture. In these pages, Indigenous philosophy and scientific precepts exist alongside new age terminology and religion. These disciplines work together in bringing forth new perspectives on who we are and why we are here.

I must also add that I do not speak for my people, as some of what you will read clashes directly with our cultural

teachings. No apologies are made for this and I will only say that in light of the world's current state, speaking one's truth is more important than blindly observing social or cultural protocol. The time to share knowledge is now.

Spiritual awakenings can occur anytime during a person's life. Mine took place one late afternoon at home in Calgary, Alberta. I was 22 at the time. Depressed at my life's lack of focus and direction and wondering if I would ever be able to make a difference in the world, I had decided to take a nap. Just as I rose from slumber an hour or so later, I heard a clear sounding voice.

"You'll get it anyhow, don't wonder."

Instantly I shot up to a seated position to see if anyone was around.

I was alone.

Then came the dreams.

These consisted mostly of confrontations and battles between myself and giant lizards, bears, rams, armored knights, and crocodiles. Dreams of triangles and eventually

pyramid shapes such as ones found in Egypt also started manifesting themselves, along with visions of abstract symbols. Other visions were of scenes that described key periods in humanity's history and prehistory. I even started feeling light physical touches on my skin - almost like drops of water or wisps of cool air. Again, this occurred when I was alone. Precognitive dreaming became a common occurrence. I often knew by what I had dreamt the night before who I would come in contact with or what events would take place the next day.

With my life starting to feel like episodes from a science fiction movie, everything else in my life became a low priority. My focus shifted to finding out what was happening with me. I knew that someone was trying to communicate, but who and why? Desperate, I had to find out. So a decision was made: I would paddle a canoe for 2,400 miles in the Canadian wilderness. Nature, I felt, would provide me with answers.

To shorten a long story, the canoe trip took place and was an immense success.

Canoeing had given me two passions: wanting to make a difference and environmentalism. For the next three years, I gave lectures, speeches, and workshops in schools and universities. Besides canoeing, students and I discussed global awareness and reawakening the planetary heart towards Nature.

Many Indigenous and environmental conferences were attended as well, and people met at these gatherings often became great friends.

For instance, I stayed in Australia for five months to help organize a world Indigenous youth conference. Periodically, my friends and I would take off on short camping trips in the outback. We would exchange cultural teachings and they would delight themselves in watching me eat goanna (a type of lizard), barramundi (a fish), and other traditional bush tucker.

Prior to Australia, I was in New Zealand for a month keeping company with the Maoris. Another time, Old Crow in the Canadian Yukon was my destination, where I stayed for a month with the Gwich-in First Nation. I also spent nearly six full years in Northern Quebec with the James Bay Cree. During these travels, much time was also spent listening to stories and learning wilderness survival techniques from Indigenous elders.

My tastes in music during this period also changed along with my lifestyle. Hard rock was more or less abandoned in favor of more gentle and relaxing melodies ("nature serenade" tunes and ethnic music for example). These tunes allowed for more than simply hours of pleasant driving. They gave me opportunities to daydream. Sometimes all that was needed for a journey was a certain chord of music. My mind and eyes were still alert to the road's demands of course, but my Spirit was far away.

Depending on a journey's intensity, I would sometimes perform weird acts; like veering off the main highway and

onto isolated country roads. I would step out of the vehicle and walk - spending a few minutes meditating. Other times I would slow down to a halt in front of a highway road sign and stare at it like a zombie. Anyone trying to have a down to Earth conversation with me during those times would have been out of luck. I can laugh about it now, but I lived in a dreamworld back then.

My biggest issue with all this of course was: *why is this happening?* First there were bleeding noses, then came the voices, touches on my skin made by who knows what, a total change in my beliefs and lifestyle and now these dreams - what did it all signify? "Hey you up there," I once yelled, "why don't you dump your garbage on someone else?! You haven't said what is expected of me. Take it back - take it all back!"

Getting angry did not do an ounce of good. Whatever was trying to drill something into my head simply stomped its foot down harder. Almost overnight, the pace of these spiritual learning sessions *skyrocketed*.

Over the next few years I developed a raging desire for knowledge. In addition to spending time alone in nature or listening to Native elders, I often read to satisfy my hunger. In the years that followed I read all that I could about the sciences as well as world religions and spirituality. Though only a portion of what I read resonated with me (especially in regards to human origins and the Great Pyramid), my dreams would sift through the information and provide me with a much clearer understanding of whatever I was studying at the moment.

Eventually, I had gained a powerful new awareness - the same kind that people who undergo near death experiences often gain. By immersing myself in nature, learning from elders, reading material I felt attracted to and deciphering dreams, I had become "aware". Almost by surprise, I knew how humanity came to be as well as the reason for the Great Pyramid's existence.

Not knowing what to do with this information, I phoned one of my Native elders for advice. Grandmother's words

ring clear to this day; "Stéphane," she said, "you've been given the gift of understanding ancient knowledge. You're going to write a book about what you've learned and share it with the world. There are others out there like you and they need to know they are not alone. Just don't feel too highly of yourself; the ideas you'll be writing about aren't new - they've been around for many years. You're simply able to interpret them differently. There are many others like you with similar gifts."

Within days, while visiting family in Quebec, I began typing out what the "source" had taught me regarding Egypt's Great Pyramid and human origins. A few years later, DREAMING THE PYRAMID was born.

As for the voice, I am still unsure what to call it. I like saying "Spirit" best. "God" or "Higher Self" could be other terms I suppose. Labeling or giving something a name sort of "kills" its essence I think. It can prevent further understanding from taking place. For my people, it is the reason why the word "God" in our language (*Manitou*)

translates philosophically into *The Great Mystery*. We would rather keep our understanding of immensity just out of reach - even if we feel we have an understanding of the way it works. It is a form of respect as well as ensuring that our growth and evolution will never cease. Kind of like how a garden plant perpetually reaches for a string tied above it so it can latch onto it and grow. The real growth takes place in the pursuit, not when the goal is achieved.

To me, Spirit represents the divine part of us that dwells within all that is. Spirit is in you, me, the Mother Earth and all her creatures, the Galaxy, Universe - everything. Spirit is the common denominator to us all. Access Spirit, and the doors of a huge spiritual information database swing wide open. I suppose in dominant cultures this database or library would be called the *Akashic Records*.

Read these pages both literally and between the lines then, for often what is openly stated carries lesser impact than what is secretly implied. Every sentence voiced here has its purpose.

Our collective challenge is to share knowledge allowing us to save the planet from ourselves. We are at war from within and without you see, because we do not recall who we are.

Who we *truly* are.

The laws of physics dictate that every action has an equal and opposing reaction. A philosophical version of this law would be that if humans are capable of killing the planet, it must be because they once played an active part in bringing it to life.

Hello, and welcome to *DREAMING THE PYRAMID*.

THE PRIMER

As bizarre as it may sound, when I look at people, I see beings I was once intimate with long ago. I see *soulmates*.

These feelings extend to include absolutely everyone I know and do not know; friends, athletes, business people, fellow authors, actors and actresses, singers, public officials, strangers on the street - everyone. My upbringing is partially responsible for this. From as early as five years old, my father and I would take long drives in the Saskatchewan countryside looking at the clouds, trees, and the animals. We rarely had a destination. We would just

hop in the car and go (sometimes for well over a hundred miles). My people are like that - free spirited and adventurous. Mom did not mind our outings, we always returned in time for supper. Besides, they probably gave her a nice break from my asking her so many questions. Anyhow, during our escapades dad and I discussed things like love, sharing, respect, and the ways in which we are all related.

"Son," he would say while pointing out some mallards flying up ahead, "the air that you're breathing isn't your own. It gets shared and passed on to others too. See those ducks? Well, they're breathing the same air you're breathing. The same thing with the deer, the rabbits, and even all the little gophers. Everything is tied with one another."

"Really?" I would say while aiming an imaginary slingshot at one of the ducks. "You mean like strings?"

"Heh heh...yes son," he would reply grinning, "that's right. Like strings. It's all connected."

"Every flower and plant and animal can teach you something," he added. "The rocks and the clouds too. Even they have lessons to teach you. All you have to do is close your eyes and listen."

I shut my eyes and imagined myself talking to a tree and listening to what it had to say. All I could hear was my growling stomach.

"Hey dad, let's go back home - I'm hungry!"

"Ok son. You're right," dad would say with a grin, "we went far enough today. Let's go home and see what your mother made for us."

And back we went, talking and laughing.

I would like to believe that I understand all of my father's teachings, but they are only now starting to sink in.

Having grown up with this kind of cultural mindset then, it is hard not to feel saddened when witnessing the apathy we sometimes display towards each other and Mother Earth. Atrocities such as wars, environmental

degradation, murders, suicides, and social intolerance should be fiction to the world, not fact.

Pinpointing where we went wrong is easy. Chaos was born when humanity lost its spiritual path and became less intuitive and feeling. By divorcing science from Spirit, we have created a world where Nature and society rarely benefit from our actions.

In my opinion, having faith in the powers of science alone to fix the world's problems is an unwise move - its wings are too tender and inexperienced. We simply do not yet possess the necessary experience and wisdom required to have science fix the world's problems. In less than a hundred years for example, we have gone from using the horse and buggy, oil lanterns, and old-fashioned telephones to space shuttles, lasers, and the Internet. These rapid changes have resulted in an ever-increasing fervor to push technology beyond all limits. In fact, it is hard to keep up at all with the evolution of technology. The changes are simply happening too fast.

Today's seniors often feel left behind by all the high tech hype. Seeing younger people as being smart yet a little spoiled by technology's benefits at the same time, they believe that we would not survive yesteryear's harsher lifestyles (imagine a young person today without their cell phone, car and stereo and you will understand what I mean).

My own French Canadian grandfather has often told me what it was like for him and his family during the "dirty thirties":

Eh monsieur, Grandpère would say while sitting in his rocking chair and puffing on a cigarette, people around here sure had a rough time back then! Stéphane, would you believe that my father and I used to wait for blizzards so we could go into other people's wood lots with our toboggan and cut firewood? We always made sure that the snow erased our tracks. And in the summer, my mother would tell me to visit neighbor's gardens at night with our wheelbarrow. I was an

*expert at leaving no trace that I was in their patch
taking what we needed to eat. Eh maudit young people
have it easy today!*

Point taken Grandpa. I believe you are right.

Indeed, most of us living in towns and cities cannot recall performing arduous chores like our grandparents did. Chopping wood, fishing for food, and spending entire afternoons picking apples and berries are hobbies - if they have ever been experienced at all. Modern needs are met by turning on a tap, punching in a number on the automated bank machine, or picking up the phone. Our lifestyles are quickly becoming so artificial and self-involved that for many, believing in something greater than ourselves seems almost ridiculous. In other words, we have numbed ourselves to the divine.

We have also become fearful of the unknown.

Many of us are so obsessed with having enough money to secure our future that little time and energy remains at day's end to dedicate towards the natural world.

This alienation between each other and Nature is everywhere. Walking down the street, we rarely look into each other's eyes. When we do, the glance is rarely accompanied with a smile. In more relaxed gatherings, we immediately judge new acquaintances. If anyone fails to meet our standards, they are quickly relegated to the corner with only the rubber plant for company. A degree of emotional distancing accompanies even our closest relationships, often making strangers out of loved ones.

Life need not be like this. Things could be otherwise. A sense of the genuine and reverent might return if we took the time to see and appreciate all the wonders and mysteries surrounding us. Our spiritual understanding would thus be greatly enriched, and eventually, so would our relationships.

What are some of these wonders? Well, just look at the conditions under which we live. This is a miracle in itself.

Space: Home to Neighbors Near and Far

My passion for the past is balanced with an appreciation for today's cutting edge technology and discoveries. Whenever I am in the mood to be awed, the mouse is clicked onto NASA's "The Best of Hubble Space Telescope" web site (sorry, I would list the Internet address for you, but you know how these have a habit of changing). This great site shows amazing views of star clusters, nebula, and supernovae.

What I find particularly striking about the site is when its administrators say that the surface area covered with each photograph taken in space is the equivalent to holding a dime at arm's length towards the sky. In just one of those photos for example, viewers can see dozens of galaxies cohabiting the same area - with each of those galaxies estimated to contain over 2.5 billion star systems!

Our lives on this planet are no less inspiring. Here we are as fragile beings needing to breathe, eat, and drink to live. Resources permitting us to do these things are found

exclusively on the Earth's surface and nowhere else (to the best of our knowledge at this time). This thin-crust planet with a core of molten lava spins around the Sun together with other planets. Then this solar system exists along other solar systems within the Milky Way which in turn exists with countless other galactic entities.

Well, enough said. Eternity can only be talked about so much until it starts either getting on our nerves or bogging our minds. Anyhow, we get the picture; life within the Universe is a miracle.

Let us now go to a more personal level and see what wonders may be found.

The Miracle of Romance and Love

Whether it lasts for a month or a lifetime, being in love is one of the greatest experiences a person can have.

Here is a short story illustrating how love can suddenly "happen".

#

Susan is an attractive, single woman in her mid thirties. She is childless except for two playful and mischievous tabby cats named Ben and Troy. Susan would not mind having a boyfriend, but successfully running a fine art gallery in downtown's core is tough business (i.e. *busyness*).

After going on the bus to get to work, she walks towards the rear and sees the same old faces she has grown accustomed to seeing over the past three years.

Wait a second, she wonders as she looks down the aisle, who is that?! Susan sees a handsome dark-haired gentleman dressed in casual sportswear. He is sitting near the back and staring out the window. He must have felt something out of the ordinary too; he has turned his head to see who is coming.

Wham.

The stunned look on his face says it all. Chalk up another point for Cupid and his love tipped arrows.

Unnerved by the man's stare, Susan quickly looks elsewhere. "Nuts", she fumes, "wouldn't you know it - the

only available seat has to be right beside him too. Well, there's no way I'm standing in a bus for half an hour with high heels!"

She continues making her way down and sits nonchalantly beside him with her eyes glued straight ahead. "If another empty seat existed", she thinks to herself, "I would gladly have taken it."

Sitting in front of Susan is Ms. Romanow, an elderly unmarried woman with two cats of her own. She is wearing her usual brown blouse and white runners with pink laces. The old woman looks straight at Susan with a huge smile on her face.

"What's she so happy about today", Susan ponders while managing a grin in return. Is the corner store giving out free cat food this week or something?

Feeling trapped in between an old lady's stare and a handsome male's raw magnetism, Susan surrenders to the irony of the situation. Subtly, with her eyes still locked straight ahead, she allows her peripheral vision to "scan the

package". She notices the squared jaw line and muscular forearms that appear like they have lifted more than just office stationary. "Wow - if my dream guy were to have the perfect look", she teases, "this one's got the goods!"

Already well in pursuit, the man holds similar thoughts. While Susan turned to sit down, he threw a quick glance at her *derrière* and long legs. He is thinking about what a fox she is and how he wished he could say something interesting to spark conversation between them.

The bus moves along while excitement levels rise.

No longer able to withstand the suspense, the man ventures bravely onto the ice, hoping it will crack.

"Hello Miss," he utters in the smoothest possible tone, "my name is Sean. Are you on your way to work?"

Susan takes a deep breath and briefly reflects upon the many times she has been approached by good looking guys who quickly revealed themselves to be jerks. "Please don't let this be one of those times", she begs. Her head turns to face the voice.

"Hi Sean...I'm Susan. Yes, I am on my way to work. Are you as well?" From the corner of her eyes, Susan spies Ms. Romanow - whose smile is now practically wrapped around her ears.

"No. Not today. My vehicle's in the shop getting a tune-up. I'm going to see my niece play in a softball tournament. Actually, I'm in Multimedia. My partners and I run a video productions company. May I ask what line of work you're in?"

"Not bad", she thinks, "he can actually converse, he's employed, and cares about family too".

"I own an art gallery on Third and Main. We specialize in abstracts."

Sean's attention is aroused.

"Really? That's great. I'm an art buff myself. Abstract hasn't touched me personally, but perhaps it's because I've seen so little of it. I do dabble in watercolors though and own a few oil paintings from local artists."

That is it, the connection between the two is made. Before you know it, Sean and Susan are talking about everything under the Sun: art, work, where they grew up, their hobbies, what society should be like - anything but news, politics, and the weather. Livelier conversations have never been heard in this bus before.

Caught up in the magic of the moment, Sean almost forgets about his upcoming transfer. Time to act.

"Susan," he says casually while pulling the cord along the wall, "I enjoyed our conversation. Unfortunately, my stop is coming up. Listen, we should do something together sometime. May I ask you for your number?"

Susan smiles as she gives him a card from her purse. She does not care about who may be watching or listening. This is a one shot deal and she should take advantage of it while it is there.

"That'd be nice Sean. I'd like that. What did you have in mind?"

"How about lunch tomorrow? I know a great little sushi bar!"

"Sushi? Sure, sounds good." Susan is vegan, but she will gulp down raw fish once if it means spending another moment in this guy's company (she has not dated in two years).

"Fantastic. I'll phone you at eleven thirty tomorrow and we can arrange to meet. Take care Susan. Oh - and it was nice meeting you too Ms. Romanow. Have a great day."

"You just made it great for me, Sean," the old woman replies back smugly, "and do tell Tracy to be careful. Softball can be a dangerous sport."

Susan is flabbergasted as Sean disembarks from the bus. She wonders whether she should steal one last glimpse of him or if she should deal with the matchmaker sitting across from her instead.

"He seems like such a nice man, doesn't he dear?" Ms. Romanow says in a devilishly sweet tone. "Aren't you glad I got up from that seat just before you came on?"

Not only does the Universe often work in shocking ways, so do senior citizens.

Cut to the future: Susan and Sean have been married for a year and a half and have decided to start a family.

Out come the gourmet recipe books, vegan and seafood of course, and fancy wine glasses. On goes the soft music and candles.

The magic between Sean and Susan during supper is as strong as when they first met. Sean's toes curl as Susan begins rubbing her thigh against his leg. Too excited to finish their meal, they move into the living room for some dancing. Their eyes do the talking while bodies slowly rock to the rhythm. One by one, items of clothing start to fall to the ground.

Sean haunts Susan's flesh with phantom kisses. He then gently lays her diagonally across the sofa, exploring a landscape he finds both familiar and exciting. Susan's body quivers and shakes as he begins performing oral sex. Little

time passes before Susan finds the torture to be too strong. She wants Sean inside her. Now!

Sean's thrusts are slow, steady, and deep. He intersperses these with gentle kisses and nibbles on Susan's forehead and earlobes. She moans and groans with appreciation.

This rocking and rolling of the flesh lasts for half an hour. Suddenly Sean arches his back, closes his eyes, and opens his mouth wide. Out spurts warm, ivory fluid from his erect member. Gasping with delight, Susan squeezes Sean's buttocks with her hands while raising her hips into his. For all too brief a moment, their naked bodies feel fused as one.

Ecstatic and exhausted, the two kiss and caress, enjoying a brief rest. Two more blissful lovemaking sessions will repeat themselves before they call it a night.

Meanwhile, on a biological level inside Susan's body, other awe-inspiring events are occurring; millions of spermatozoa race frantically towards the egg.

One little speedster stands apart from the rest. He has already reached the egg's outer walls and is knocking on her door with all his might. Sensing that her suitor has the correct genetic password, she quickly opens her doors, pulling him in.

The spermatozoa and the egg unite and become a single cell. This cell then divides in two. These two cells become four cells, eight, sixteen, and so on until enough cellular mitosis has taken place to allow the formation of a little fetus - early forerunner to Sean and Susan's first love child.

Susan's pregnancy fascinates them both. They read, talk, and sing to their unborn child on a daily basis and often wonder if it will be a girl or a boy.

Then one day Susan goes into labor. Sean rushes her to the hospital and accompanies her into the delivery room. After much heavy breathing on her part (and near fainting on his), a star is born; Jennifer, a beautiful, healthy 7lbs 4oz baby girl.

Yes, a human being's conception and birth processes are definitely miracles.

But you know, as romantically pleasing as this scene was, it also exuded a somewhat raw and primal flair.

Imagine the biological complexity involved when two out of over six billion human skeletons filled with fluids, flesh and tissue decide to physically unite. Indeed, that these would even want to unite is as incredible as their ability for displaying movement itself. Picture the further juggling of universal gears required to make these two organisms safely bring forth a smaller, purplish version of themselves into the world.

Unreal.

Sorry if looking at our existence that way sounded a little unsettling. I was only stating facts.

Here is another wonder of life worth ruminating.

A Question of Shut Eye

Two senior citizens are enjoying a quiet evening in their living room. The woman is reading a book on how to make stuffed animals while her husband is watching a documentary on South American rain forests and cursing at the commercials.

"That's it," the woman says while putting the book down on the table beside her. "I can barely keep my eyes open. Are you coming to bed soon?"

"Yeah," her husband murmurs, "I want to catch the end of this first though. I'll be there in about ten minutes."

"Ok then, see you soon."

"See you soon dear."

Like clockwork, ordinary people such as these around the world slip away to their bedrooms after dark. For roughly eight hours, these souls sleep and are oblivious to the physical world's whims and demands. The same predictable pattern has occurred nightly without fail.

Realizing that every person and creature needs sleep, one has to ask why?

Why can people not stay awake for their entire lifetimes? Disregarding the body's biological need to repair and replace cells during sleep, does it not seem odd to spend so much time in a semi-comatose state? Why can the body not repair itself when we are awake and just relaxing? Instead of living for an average of eighty years and sleeping for twenty, would it not be equally as viable to let go of sleep altogether and live for sixty years instead?

Think about it. If sleep is necessary to "recharge our batteries", then what is the mysterious energy source doing the recharging? And what if a way to stay connected with this energy source was found - would that eliminate our need for sleep?

Now, I am not suggesting that we should try to get rid of sleep (I love my shut eye way too much for that), I am only asking why does it exist?

Again, I apologize if these ideas offend you.

Sometimes plowing up the soil in our minds is the only way for new ideas and insights to take root. Those old cobwebs we have allowed to become built up for thousands of years need to be stirred up a bit. We will discuss some more mysteries and move on into the storytelling.

Ready? Ok. Here is another enigma to ruminate.

The Quest for Eternal Youth

We become painfully aware of our mortality from the moment we notice our first wrinkle or gray hair in the mirror. Some of us accept aging gracefully while others do everything to try to reverse it. We can exercise our buns off, apply anti-aging cream like it is cake icing, wear cool clothes, receive implants and Botox injections, get facelifts and undergo plastic surgery - all in the goal of making us look younger and more attractive. Resisting seems pointless however, for our bodies inevitably become ravaged by the effects of time.

So the idea is this; if aging and death are intended processes, why do we have such a hard time accepting them? Are we trying to remain younger longer, or are we subconsciously fighting tooth and nail to reclaim something? And if so, could this "something" be where having perpetually youthful and immortal bodies was once a reality?

Yes, I know that the notion of living in a youthful body forever sounds ridiculous. Presently, it appears that the best way our species demonstrates immortality is by refusing to let old ideas die. Before I am dismissed as an imbecile however, ponder this; a baby's tantrums are never more deafening than after he has had a candy, he has already tasted it and liked it, and had it ripped away from him.

In other words, why would we so strongly desire to remain youthful longer unless we once could? Nothing motivates an entire society more to evolve towards achieving an ideal (in this case, perpetual youthfulness and immortality) than if that society already once lived that ideal

in a long forgotten past, thoroughly enjoyed it, and somehow lost it.

Speaking of lost ideals, let us ask ourselves a simple question regarding humanity itself.

Why Two Genders?

Have you ever wondered why there are men and women? Why are there not three genders instead? Why not four, or even five or six while we are at it? Why two?

Come to think of it, why not have just one gender? You know, kind of like a hermaphrodite or perhaps a sexually androgynous being? Would that not be a lot simpler?

In light of all the problems we have today with divorce, spousal abuse, miscommunication between genders and so on, do you not think it might have made more social and biological sense if one sex existed here on Earth instead? With only one gender, every person would know what it is like to live in the other one's skin. We would blend the

female tendency of valuing people and relationships more than things along with the male thirst for scientific exploration and philosophy. The sexes would become as one.

This ideal of having one gender might explain why so many people wander relentlessly between sexual roles and identities. Could humanity be trying to attain such a united physical state considering how many people practice cross dressing, bisexuality, and undergoing sex changes?

Hmmm. Food for thought.

Granted, having one gender sounds utopian and such change would surely upset the well defended notions and roles we have as men and women within society, but one must admit that the idea has merit.

For thousands of years, we have been told not only what and who to believe, but *how* to believe as well. These external influences have not done much to further our spiritual evolution. Now more than ever, it is extremely important that we reawaken and remember our own sacred

truths. Taking a hard look into life's hidden implications then can help us resurrect forgotten memories. These memories would then lead us into realizing how magnificent and powerful we are. And if this miracle of self-realization happened, this planet would then undergo a major makeover.

Let us progress onward and agree that a certain "*je ne sais quoi*" makes us unique in comparison to the rest of creation. Here are a few of these differences:

Are Humans Alien to Earth?

- 1) We are the only species engaged in space travel and exploration. True, primates and plants have also gone into space, but these species are not engaged in space travel. They are involved by our own doing (and rather unfairly at that).
- 2) We are one of the only species building individual living quarters many times greater our own body size.

- 3) We are the only species that feel bashful about nudity and thus wear manufactured clothing.
- 4) We are the only species dependent upon tools, either mechanical or electronic, for survival and recreation. Some mammals and birds also sometimes use tools to assist them in acquiring food, but they hardly depend on them to the same degree that we do. Unlike us, they can get along just fine without them most of the time.
- 5) We are the only species regularly keeping other species as beasts of burden, as entertainment, as food sources, and as pets.
- 6) We are one out of a handful of species that deliberately hunts down and kills members of its own kind through assassination and overt warfare (not our most endearing feature).
- 7) We are the only species possessing written languages.

- 8) We are the only species gifted with the ability to both manifest and use fire with the use of tools.
- 9) We are the only species able to dive into other species' gene pools, either modifying their DNA or splicing them with those of other species. We are even able to resurrect species gone extinct.
- 10) We are the only species whose drive for evolving seems entirely due to a desire for living in greater ease and pleasure.
- 11) We are the only species that smokes.
- 12) Aside for bacteria, we are the only species exploring and inhabiting all of Earth's continents and environments.
- 13) We are the only species able to domesticate and train other animal species around us, even rendering tame and docile species considered

extremely dangerous (grizzly bears, orcas, and boa constrictors are a few examples).

- 14) We are the only species creating artificial representatives of its own kind through robotics.
- 15) We are the only species of mammal continuously walking on two legs.

#

These are some of the differences between us and our animal kin. Regardless of which angle you look at our kind from, we are different, it is indisputable. But do you know what the most astounding peculiarity about our kind is?

These differences typifying our kind have come to us despite the fact that we have only fulfilled ten percent of our potential. This leaves us with the ability to create around nine times more powerful technologies in the future.

What do you think, have we hit our stride as a species?

No, not yet. Not by a long shot.

So, the highly controversial subject we are getting to here of course is...

Evolution? Or Creation?

Were we created in the blink of an eye by some invisible deity, or is our miraculous earthly presence simply due to billions of years of trial and error? In other words, are we naked apes, or divine creations gone "apenuts"?

Creation: A Process in Evolution

I love art. Whether it is abstract, realism, nudes - whatever. When a particularly striking piece moves me, I always wish I could meet the artist in person and ask them questions about their work. Did they know exactly what they wanted for instance, or were several sketches made first? As an artist myself, the creative process intrigues me.

Based on what other artists have shared, dynamite art rarely turns out right the first time. Artists dig way down in the muck and sludge of their soul for hours or days on end,

eventually vomiting up some forbidden emotion they can incorporate into their work.

The question of what colors and tones "feel" right can be maddening as well - as is creating the correct atmosphere. The artist fiddles around with the brush and haphazardly splashes a few spots on the canvas, just to see the results. As perfectionists, most artists either love their experiments or hate them. Few "in between" emotions exist. Test samples are either trashed or stashed.

Over time, everything seems to magically come together. The last brush strokes are feathered in and suddenly, a masterpiece is born. Then along comes a lucky buyer and before you know it, something that dwelled within the abyss of one person's soul now hangs high within someone else's home.

What I am getting to here is that creating something invariably involves Evolution. Depending on how much in touch artists are with themselves, creating a visually pleasing and functional work of art can either be quick or

agonizingly long. Ideas have to ripen and evolve in order for them to reach a state of perfection. Each snapshot taken in time during that process is a creative moment.

The philosophy also applies to the Creation and Evolution of species. We have well adapted creatures in relation to their environment today because a lot of imperfections existed in the past. The Cosmos did not exactly know what it was doing when it started creating this world and its fauna and flora, so a lot of DNA experimenting took place. "If that bird's beak is too long," the Cosmos voiced to itself, "its descendants will receive a shorter one. This fish wants to run on land? We'll lengthen its pectoral fins and modify the gills so it can run and breathe out of water".

As insulting to our kind as it seems, humans are also an imperfect species, and our minds and bodies will continue to evolve. Who knows what our kind will look like after the next thousand years?

In regards to the endless debate over "Evolution versus Creation" then, perhaps it would be best to refer truth seekers to the daily artwork happening on life's canvas. We could then ask them to judge for themselves if an artist is moving the brush, or if the Universe and Earth are simply on auto-pilot.

Which ever way one looks at the issue, a Great Mystery confronts us.

Another curiosity worth pondering is the intimate relationship our kind appears to have with fire, light, and electricity. Perhaps more links us with these elements than we realize. Yes, there must be a valid reason explaining why:

- 1) Our dying bodies can be reanimated with a jolt to the chest from a doctor's defibrillators.
- 2) Whenever a campfire is around, we huddle around it and stare into the flames while talking with one another.

- 3) Many of us "light one up" and "suck on fire" during emotionally stressful times.
- 4) Right after a wedding ceremony, some newlyweds each hold a burning flame in their hands and unite these by lighting up one candle.
- 5) Our vocabulary is saturated with expressions such as: the path of *enlightenment* and *illumination*, one twin *flame* to *brighten* my days, come on baby *light* my fire, I'm all *fired* up, having a *bright* idea, that gave me a *jolt*, he has *fire* in his eyes, shedding some *light* on the matter, *spark* up some interest, I have a *sunny* disposition, I want to be a *star* someday, etc...

#

Such marvels and mysteries exist for a purpose, and it is good that we review them. Doing so is not wasted energy. By the time this book is finished, we will have come up with new insights, believe me.

Still, a troublesome question remains.

Is it not sad that life's wonders such as these had to be presented at all? Do you not think that we should have already been thinking about these mysteries since we were kids?

Maybe that is why life seems to have lost its magic; our thinking has grown old.

New Beginnings

Here we are then living in the "modern" age. The more we look around, the more we see that Spirit world has played yet another trick upon us; knowing who is who amongst us is no longer so easy. Skin color and clothing do not reveal who people are on the inside anymore. The Caucasian person we see on the street, for example, may have been raised within a Negro family and identify more with that reality instead. An Asian woman waiting at the bus stop might not know how to speak her culture's language. In fact, she may not even relate with her culture at all.

Our children are no longer just red, black, yellow, brown or white either, but varying blends of these. Nothing in the world is separate. Nationalities as well as religious and spiritual beliefs are as mixed as the weather patterns. Even some Native people have completely forgotten the old ways, while many non-Native people are living gentler and more ecologically sound relationships with the land. Perhaps historical paths were meant to join in this manner, who can say?

I sense that anticipation for the storytelling is mounting. Put your projects aside for a few moments and pull up a log or blanket to sit with us by the fire. Also, please make sure that you bend right down before entering the lodge. Someone last week did not and I spent over an hour fixing the door. That should teach me next time to make sure I say something.

A tale commences shortly. We will speak of an era long ago when the Gods walked amongst us. As fantastic and

enticing as the story will sound, it may be a while before this period returns. Many baby steps may need to be taken first.

So rub on some bug repellent if you are not used to the mosquitoes. They can be pretty thirsty this time of year.

Speaking of thirst, some fruit juices and coffee are in those thermoses over by the cups. A friend of mine also made us some sandwiches and cut vegetables with dip. So do not be shy. Help yourselves and get comfortable. Do not worry about feeding the fire, someone else has already been given that task.

What you are about to hear is the oldest kind of tale, one that has been told around fires like this one for eons.

If you are ready, we can get started.

Our story begins...

THE CIRCLE

From Eternity We Originate, To Eternity We Return.

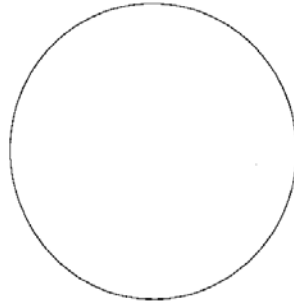

Figure 1. The Circle of Life

The Circle. It has no beginning and no end, and it is the same with you, I, and everyone else throughout the Universe. We were never created, and we will never cease to exist.

The haven that Western cultures have come to call "Heaven" is a bright and powerful Light. In that Light, we are Spirits. Solar Spirits.

In other words, Angels.

Our bodies are different in that state. They are similar to our current ones in terms of possessing limbs and vital

organs, but different in that they are made of Light. They transform themselves by our will from huge to small, luminous and transparent to opaque, light to dark toned, muscular and angular to curvaceous and soft, and so on for an infinite number of possibilities. Where our minds take us, the body and reality follow.

In the Light, we are not confined in any shape, form, color or size. Not in time, space, age, thought pattern, environment or appearance, unless we *want* to be confined, that is. Each Spirit can appear as an eagle, a lion, a lamb, tree, wild mustang, burning flame, a rainbow, crystal, differently appearing humans, etc. In the Light, one can choose to live in a tee-pee, a mansion, a cave, in an ocean environment, the desert, the Cosmos, a forest - anywhere and anyhow one desires.

The Light's colors are so beautiful and soothing that few artists can come close in replicating them. What passes for music and the sounds of our voice as well here on Earth is dwarfed by the Light's melodies.

Spirits feel emotions for and from everyone else. What others think, we think. What they feel, we feel. They are an integral part of us, and we are a part of them. Everyone is mother and father, brother and sister, best friend and lover, and child to everyone else at the same time. And as shocking as the following may sound, it is true.

In the Light, we are in love with every other Spirit. All at once.

This is so for in the Light, marriage, as we think of it here on Earth, is non-existent. In the Light, everyone is intermarried with one another. Spirit being energy, and energy being in constant fusion with itself, how could this not be so?

With that kind of interconnection going on then, is it any wonder why people who have undergone near death experiences have trouble describing their beauty? The Light literally defies description.

So you see, feeling envy regarding other people's love lives does not do anyone any good. Since we come from the

same source, we also return to the same source. This means that everyone eventually can choose to fuse again with the Spirits of people they have admired such as actors and actresses, singers, athletes, world officials, and so on whether these people have lived in the past, are alive now, or are not even born yet. In that sense, it becomes easy to see that in the Light, romantic fantasies are not fantasies at all.

They are memories.

Of course, this does not mean that becoming intimate with everyone in sight should become our focus. We were given specific relationships with friends, family, lovers, and strangers here on Earth and should honor these. Just remember that if we are not content with our love lives now, these feelings can be washed away when we pass from this Earth and enter Heaven's love once again.

Being united with those we miss and/or admire sounds appealing. Keep in mind that the same rule applies to those considered as the scourge of society: rapists, convicts,

abusers, serial killers, drug addicts and pushers, beggars and prostitutes.

Everyone makes it back to the Light.

Everyone.

Even if it takes millions of lifetimes to do it.

What is the Light?

In a simplified manner of speaking, the Light, or Heaven, could be defined as being seven entities forming a unified whole. These seven entities are the six visible colors contained within the rainbow spectrum of light: red, orange, yellow, green, blue, and violet. The final, and invisible, color is the last part of Heaven (thus making it the "seventh" Heaven): ultraviolet.

When vibrating with one another, these colors fuse and form what we call Heaven's "white" Light.

Now, it came to pass that our love for one another in Heaven grew stronger. Like a gigantic lovemaking session, the Light throbbed and came to a climax. This cosmic

orgasm then went forth across the Universe. Here was how we as Solar Sprits dwelling within the Creator's Love gave birth to one of the Big Bangs (many have occurred before the last recognized one, and more will come to pass).

Slowly, these Light particles came together and fused, with each group eventually forming its own solar system.

Being merely Solar Spirits and not the one Great Spirit, we could not create anything, but could help expand upon and modify what already existed. In short, we were co-creators.

Now the Universe has a peculiar nature. Electrical power is what it is based upon. Here is a visual depiction of this universal power source.

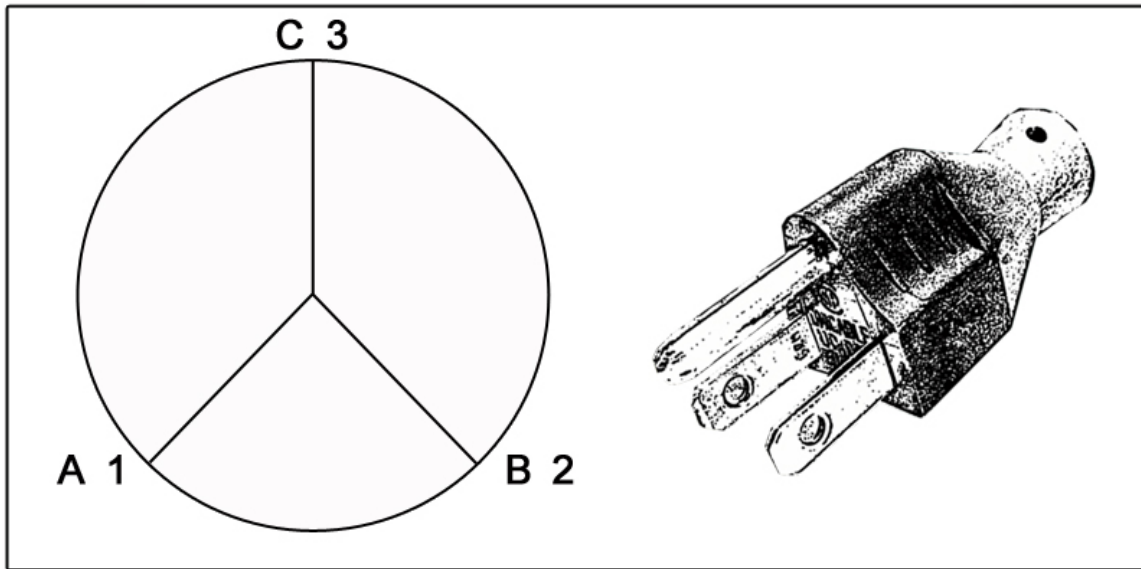

Figure 2. A Holy Trinity

The Universe's first energy is the A. The 1. This force is primarily male with some female energy. An earthly equivalent would be the positive wire found in electrical wiring.

The second energy is the B. The 2. This energy is primarily female with some male energy. Think of it as the negative wire.

When two beings feel attracted to one another and unite, a third energy is created - a Child energy. This energy retains the characteristics of both parents within

itself and can be thought of as being both male and female at the same time. This energy is the C. The 3. The Christ. The electrical ground wire.

So we have the sacred A B C and the 1 2 3 dwelling within the Circle of Life. A sacred trinity of the Father, Mother, and Holy Child.

We lived well as Solar Spirits. Like a heart that pulses in and out, we enjoyed the processes of reassembling with other Light Spirits in the Universe so that other wildly orgasmic Big Bangs could be experienced.

But something shifted within us at some point. Having free will, we began "questioning". We started becoming a little more independent in our thinking from other Solar Spirits. This was not "evil". It was simply different from what we were used to.

The Decision to Create

As Solar Spirits, it was as though a thousand ice cream flavors lay before us. Until that point, we had tasted all but

one of them. One virgin flavor remained. This flavor was our curiosity as to what it would be like to test our own creative abilities to see how far they would take us.

“What would having our own little experiment be like,” we then asked ourselves, “the powers of expanding and modifying were given to us weren’t they? Let’s use them!”

And in terms of how we interacted with our newly formed cosmos, use them we did.

A Binary Solar System

In her best selling book "LINDA GOODMAN'S STAR SIGNS", the late author Linda Goodman states that our original solar system consisted of not one, but *two* suns.¹

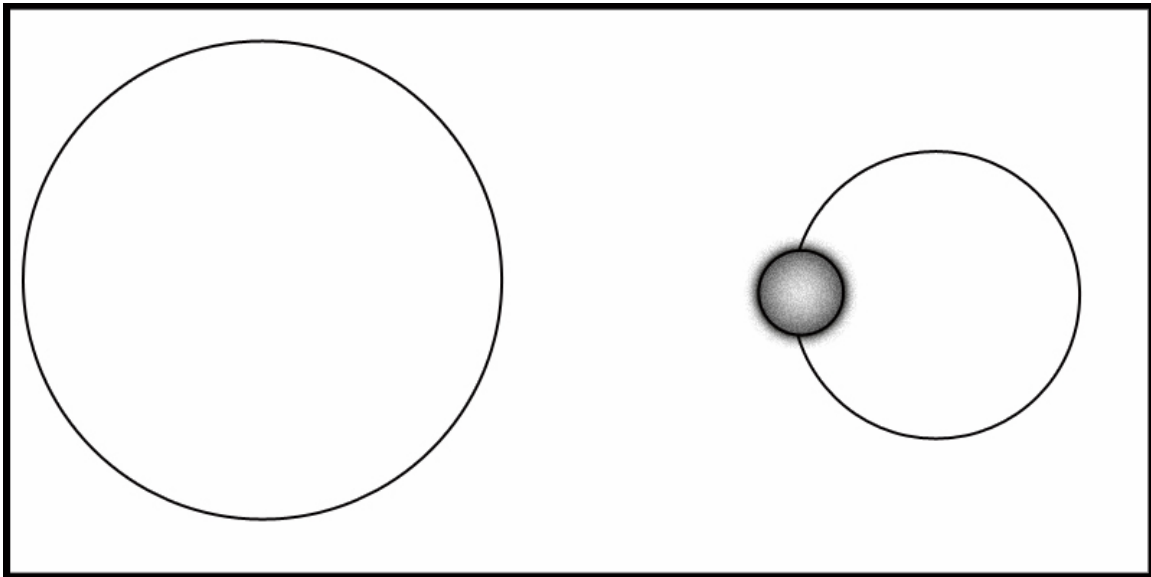

Figure 3. Our Original Solar System.

Two Suns?

A binary solar system?

Here?

Not an impossible scenario. After all, modern astronomers have already firmly established that binaries

¹ Linda Goodman, LINDA GOODMAN'S STAR SIGNS, ST. MARTIN'S GRIFFIN, New York, NY, 1987, p. 411

exist throughout the Universe, so the possibility of our once being part of a binary solar system is not science fiction.

As I mentioned earlier in the book's introduction, analyzing the Bible became one of my favorite spiritual pastimes. One series of passages troubled me in particular. It was the first few lines in the Book of Genesis. Every single time I read them I found myself wondering if our present Sun had a far more interesting past than people realized.

Here is what the holy book has to say in regards to the origin and formation of our solar system:

In the beginning God created the heaven and the earth. And the earth was without form, and void; and darkness was upon the face of the deep. And the Spirit of God moved upon the face of the waters. And God said, Let there be light: and there was light. And God saw the light, that it was good: and God divided the light from the darkness. And God called the light Day,

and the darkness he called Night. And the evening and the morning were the first day.

Genesis 1 v. 1 - 5.

Claiming that there is evidence of a binary solar system within these passages seems extraordinary, I admit. The challenge is to look deeper.

First the reader must ask himself: why does the Bible say that the Earth was void and without form?

If our current solar system was indeed once a binary, then the Earth, nestled snugly in between both Suns, would have had little reason to rotate or revolve (or at least not in the manner in which it does now). During the birth and formation of our solar system, the Earth and even the two Suns themselves would initially have been clusters of dust and gas. The lack of our planet's rotation and revolution implies in turn that gravitational force required to render it "solid" must have been nearly nonexistent.

How did the Earth become dense then? The obvious scenario is that one of our two Suns must have been "taken

out" of the picture. This would have made the Earth spin around the remaining Star and generate tremendous levels of gravitational force, thus rendering her more solid.

Could the act of "dividing light from darkness" be the Bible's way of saying that one Star was destroyed? Possibly. If a second Sun *was* somehow eliminated, the result would clearly have been our planet's initial rotation and revolution around the remaining Star, and thus its first cycle of night and day - of light and dark.

Our missing Sun, the one that was wronged by his brother, may one day reappear - either literally or symbolically. The return of this Sun may have as much to do with a "Christ consciousness" as it does with an astral body. Perhaps more links us with our solar system, galaxies and the Universe than we suspect.

#

And so this death of one of the two Stars that sent our Mother Earth spinning around the remaining Sun provides spiritual insight into the origins of Earth's gravity, density,

and electromagnetic field. The four cardinal directions and four seasons also began here, as well as Earth's first revolution and rotation and the first rising and setting of the Sun. In short, this was the "dawn" of time.

Our Earthly Laboratory and Playground

As Spirits, we played a vital part in this planet's evolution. One of our strongest roles was in genetic engineering. We helped manifest every single plant and animal species in the world.

Of course, since it was our first time exploring these abilities, we started small - tiny bacteria and single cell organisms, for example. Entities that functioned well were allowed to remain and propagate, while the ill suited wound up being recycled and reworked. Eventually, our artistic abilities flourished and all sorts of plants and animals came to be.

Though we have forgotten about these sacred skills, they are returning fast in the form of our collective

knowledge gained in the field of genetic engineering. The only difference is that long ago, genetic research did not take place within a test tube or under a microscope. *We* were the technology.

In this original Earth then, plant and animal life was so diversified and abundant that the senses were burdened. Marine creatures churned the waters, insects crawled in masses, and beasts great and small roamed everywhere.

Creating a biological realm teeming with life is one thing. But at what point did we decide to live within this realm ourselves? More importantly, how did we do it? Indeed, how did we take on physical bodies?

Becoming Physical: Taking The Plunge.

When it comes to human origins and how we as spirits came to inhabit flesh bodies, I feel that *There Is A River: The Story Of Edgar Cayce*, by the late author Thomas Sugrue, is one of the only works that managed to get it right. A paraphrase and summary of his writings on the matter would be that;

"Spirits engaged along with the Universal Mind in co-creating the world and its creatures gradually became interested in experiencing things from their perspective. Gradually, they began to 'take over' the will and minds of these creatures. The end result whenever this occurred was a flesh Being that was highly self aware and intelligent".²

The picture being painted here is not particularly pretty. Essentially, we kidnapped other species of animals by taking over their awareness and bodies for our own desires and needs.

As spirits eons ago, we played a part in creating the experiment called Earth. But observing it was no longer enough. We wanted to see what it would be like to *live* in the experiment.

If this sounds like heresy, simply observe how our species relates with the natural world to this day. When we want to tinker with an animal's DNA for instance, do we ask for permission before taking cell samples from its body? No.

² Thomas Sugrue, *There Is A River: THE STORY OF EDGAR CAYCE*. A.R.E. Press, Virginia Beach, VA, 1997, p. 311

We either shoot the creature with a drugged dart or imprison the animal in a cage and take what we need when we need it. And as a whole, we certainly make no fuss either about imprisoning billions of creatures in factories and pens to accommodate our desire to eat flesh.

Infiltrating creature's bodies and minds long ago was an extremely aggressive step on our part. It allowed us to have access to physical sensations while rendering the animal subservient to our will. Chaos ensued as these poor creatures started behaving with each other in ways they would not have had we not hijacked their awareness. Could we justify our actions? Greedy for thrills and adventure, we certainly thought we could at the time.

This powerful fusion of animal flesh and will of the Spirit existed for an extraordinarily long period in the Earth. It is the reason why some people carry strong affinities with dinosaurs and other creatures that existed prior to man's appearance on Earth. It is not that they ever *were* these

animals, they simply remember what it felt like to inhabit the creature's bodies and control them from the inside.

The notion that we once hijacked other species for recreation and pleasure seems unbelievable at first, but this tendency of ours still exists - mainly in the form of our fascination and passion for modern vehicles and driving. Submarines, heavy machinery, recreational motor homes, automobiles, trucks, planes, helicopters, motorcycles and even bicycles and skateboards are all essentially "creatures" in a lesser evolved, non sentient, and mechanical form. Few differences exist between a car and a horse for example; both have eyes (headlights or windshield), four legs (wheels), a mouth (gas tank), an anus (rear exhausts), a need for food (or fossil fuel, which, just like food, also comes from organic matter) and horsepower. And as advertising executives know all too well, the act of driving a high performance vehicle symbolizes freedom and sex appeal to the young and impressionable. The way we relate with vehicles then is simply a carryover of our kidnapping of

other species for fun and travel. In fact, if one believes that today's machines will one day become sentient beings due to their continuing refinement and sophistication and eventual fusion with Artificial Intelligence, the act of operating any kind of vehicle can actually be seen as a form of slavery.

And so it came to pass that daring yet inexperienced Spirits, firmly immersed in this planet's sensations and thrills, were thrown into this earthly mess.

A Spiritual Battleground

Chaos in the Earth could not be allowed to go on forever. Something had to happen to remedy the situation. Paraphrasing Sugrue once again, the author goes on to say that:

"A means of breaking away from being trapped in the Earth was devised for souls, one they could use to return living in accordance with the divine plan. Of the many species of animals available, a type of ape was deemed the most suitable vessel. Souls guided these creatures in

leaving behind their tree dwelling existence and becoming more refined in mind and body. Once these creature's manner, behaviour and appearance closely resembled those of the souls assisting them, their bodies were infiltrated and man came into existence."³

An ancient and terrible war has raged between souls in Heaven since the very beginning. One side works to help people create beauty and harmony on the planet, while the other works through apathy and ignorance and delights in seeing people mistreat themselves, each other, and the Earth's creatures.

Being spiritual should automatically mean being good hearted then. Unfortunately, it often does not. There are highly spiritual people and spirits out there that are at odds with the Universe in their thinking and actions. Either consciously or not, these misguided souls place themselves directly against those working for the Light.

³ Thomas Sugrue, *There Is A River: THE STORY OF EDGAR CAYCE*. A.R.E. Press, Virginia Beach, VA, 1997, p. 312

Earth has become a battleground, and we, the prize. Without trying to sound fatalistic, let us just say that not everyone has our best interest at heart. Be discerning in what or who you choose to listen to when seeking counsel. In case of doubt, use your head, but trust your heart.

Because living in the Earth in a physical body is so difficult even for higher evolved Beings, laying blame on anyone for the world's predicament is pointless. Throughout this spiritual war, some loving Spirits have forgotten their divinity and "gone to the dark side" so to speak, while many Spirits that were once ignorant have turned themselves around and now work for the Light. This is why the Heavens monitor us - and you - closely. Free will is extremely powerful and dangerous, and the Universe knows this.

One thing is certain: the Light and its emissaries will not stop in its pursuit to turn things around for the better.

So, our goal as Solar Spirits desiring to experience life on Earth had been achieved. We were now able to live in

bodies that were both of Spirit and physical at the same time. These bodies were composed of four elements:

- 1) Earth: giving us our body's physical texture and form.
- 2) Air: oxygenating our body's blood supply and giving us the "breath of life". Today, this occurs for us at birth when the doctor forces air into our lungs.
- 3) Water: making up over eighty percent of our body mass and preventing us from drying up. The water element also helps regulate our body temperature through perspiration.
- 4) Fire: giving us the "spark" of life and keeping our core temperature at an even keeled 98.6 degrees Fahrenheit.

We eventually became the first human beings. Created as an extension of Spirit, this earthly puppet could roam around on the planet taking full delight in the five senses.

Since we came from Heaven's Light, upon appearing in the Earth we decided to bring Heaven with us. So we placed

Heaven's seven rainbow colors in our little Earth bodies along the most strategic spot - our spinal columns.

The most raw and crude of these seven Heavens resides down at the tail end of our spines, whereas the most ethereal and spiritual is on top of our heads. They work together as a whole, for the highest cannot operate without the lowest. Today, these connection spots with Heaven are called chakras.

So you see, each one of us has Heaven within. How brightly these colors show depends on our mind/body state. Are the colors going to be repressed, muddy and unclear because of anger, fear and sadness within us, or clear and bright because we choose to heal and clarify our lives? The decision is ours.

Third Eye

Besides the five senses of the flesh, there had to be a sixth sense - one linking us with our spirit. This was the "mind's eye". It acted as a link between occasional Earth

existence and Heaven, like how a modem connects a computer to the Internet.

We took the sixth sense and placed it inside our foreheads. This sense is more or less active in all people. We are talking about what most have come to call "third eye". This eye is not an "eye" per se, it is simply a gut feeling or instinct that allows one to feel or sense incoming spiritual instructions. For some, these instructions might be voices or physical touches that occur when no one is around, a message that we see in a movie or hear in a song. For other people, spiritual messages might be what they see when they look at treetops, clouds, animals, or other people. Sometimes, it is what they see when they close their eyes and concentrate. The more one dissects and analyzes third eye, the more it slips away. Third eye works by intuition rather than with logic. One has to surrender the mind and ego and feel it working.

When Spirit wants us to do something for our own protection, enjoyment or growth, third eye is the mediator. Third eye is our doorway to other dimensions.

The following illustration shows the visual relationship between us, Spirit and third eye.

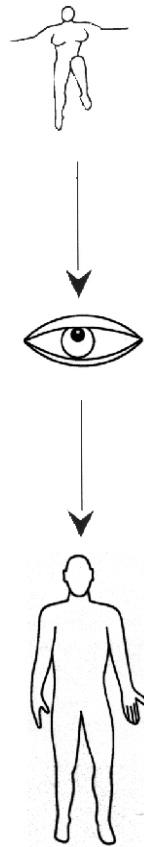

Figure 5. The Human/Spirit Relationship.

Do you remember being a kid and playing that fun game "Simon says"? Well, the game "Spirit says" is similar; we progress as we obey our inner voice, and we regress when we shove it aside. When a person calms their mind down and reactivates third eye, the challenge is to do what Spirit says and not fight or swear at it. Trying to outdo or outthink Spirit is useless, for third eye is a high seeing sense. It watches for miles and miles - even throughout the past and future. Spirit has an eagle's perspective on things, so it sees a lot better than we can. If people realized that what makes us happy is exactly what Spirit tries to give, they would resist less.

An Unencumbered Paradise

The Earth we dwelt in was void of material trappings. In Eden, we neither wanted or needed highways and automobiles, money and bank accounts, clothing, make up, jewelry, licenses and permits, buildings and statues, careers and jobs, houses, watches and clocks, nationality,

governments, police and armed forces, electrical power lines and stations, fences, weapons, taxes, borders and customs, social hierarchy, passports, or even language, names, and religion. None of these entrapments burdened us. None. All that existed here was us and the natural world in all its glory.

Star Travel

Space traveling was a reality for us as well. Our "craft" was a percentage combination of our astral and semi-physical bodies. This could be made visible or invisible to earthly eyes, metallic or non-metallic, flesh like or non-flesh like, luminous or non-luminous, sphere, crystal, rainbow, disk, cross or saucer shaped - whatever.

Traveling beyond light speed in outer space first meant conquering the scarier depths of our inner selves. We asked Spirit for protection of our bodies while we were gone, and entered deep meditative states. By asking Spirit to take our

breath away, Spirit "abducted" us and, upon reaching the desired destination, Spirit reshaped us physically.

Yes, as ironic as it may sound, in order to fully live back then, one had to be willing to release all ties to Earth existence and "die" (so to speak). Then whenever Spirit wished to bring us back to our bodies, we simply entered them and woke up. Easy come and easy go.

This notion of dying and being taken by Spirit has nothing to do with the heavily distorted version cult leaders have coerced their followers into believing by making them commit suicide. Dying and meeting with Spirit was more like a deep, painless sleep where the heart and breathing stopped, or did not stop - depending on how long a trip Spirit had in store for us, and one just left. When we wanted to return, we simply came back. Easy as pie.

Yes, as Earth visiting Spirits, we had the best of both worlds. Better than that - we had a foot in each one. We freely indulged in Earth's pleasures while still partially basking in Heaven's glory. Boy, we were clever rascals. Not

only did we make our cake, we found a way to eat it too.
We had it made in our scenic wonderland. Within each of
our minds, it seemed as though the cosmic honeymoon
would last forever.

Has it though?

Or have we been stuck with the bill ever since?

What on Earth went wrong?

EROTIC SOUL EXPRESSION

How To Trap A Monkey

In your opinion, what scenario eventually takes place in a beautiful, spacious and sensual environment filled with billions of loving and nude sentient beings?

Before you answer that, here is another way of asking the same question.

Suppose a parent places their child in front of a gorgeous black forest cake and says: "Now here's your cake dear. Don't eat too much at once or else you might get sick. I'm going to leave you alone for a while. When I come back, I'd like for everything to be in order, ok?"

What do you think will happen while the parent is away?

Chaos is what happens in both instances (not to mention one heck of a party).

Reason for the Fall

So you see, it was not "sinning" that created today's mess. Though we had modified our star system and so on, we could have chosen to surrender our puppet bodies to Earth anytime we felt like it. As Spirits living within the Great Spirit, we had free will. We only came here to experience the wonders of living in a custom designed world. Just to check it out.

We slowly but surely got so enmeshed in the human experience and its pleasurable flesh sensations that our true identities as Solar Spirits became almost totally forgotten. This incident caused third eye to shut down, causing a temporary disconnection with Spirit. We went from being immortal...to mortal.

Could this tragedy have been avoided? Probably not, and here is why.

Here was our first taste of delicious foods, the trickling of cold spring water down our throats, feeling superhuman strength and speed - all never before experienced physical sensations. How could we resist them?

But our biggest pleasure no doubt, was when emotions for one another manifested themselves through lovemaking. Inhibitions were unheard of as erotic love was expressed openly with other Earth visiting Spirits. And though Earth sexuality does not even compare with the Light's ecstasy, sex on Earth felt nice as a side dish anyhow. Like a tasty salad accompanying the main course. Not essential, but nice. Earthly sex was supposed to be a treat, an expendable luxury.

Yes, we loved this dense vibration so much that we forgot it was simply a distorted version of the Spirit world and not the real life. We began living purely for our lower selves, neglecting to pay attention to Spirit. As we involved

ourselves more and more with Earth's sultry temptations, the Gods who once walked with us gradually became forgotten, thus turning us into fallen angels.

We have been misinformed. In fact, we were never banished from the Garden of Eden. We merely became stuck in it, and what was once a great place to visit quickly became hell to live in.

Once third eye blinked itself shut and Spirit connection was put aside, we became destined to undergo the painful process of physical deterioration and death. We then crossed over into Spirit world while our physical selves remained behind to rot. What came from dust returned to dust, and what came from the Light returned to the Light.

The Gender Split

As we traveled into the Light, Solar Spirit (in whatever form it decided to take on) greeted us. If Spirit wanted to appear as a dove, a feather, or an immense winged being,

that is what it did. Regardless of how Spirit appeared to us, we were welcomed lovingly yet sternly.

"People," they said, "you've become mere shadows of your former selves. You were once great and powerful spiritual beings who have now forgotten who they are. You can stay awhile and rest here in the Light, but you must eventually return to Earth. You need to become spiritually aware again before we can give you back all your abilities."

How could we argue? We knew that our higher selves were right. Our lives were shown back to us on the big screen and we saw as plain as day that we had gone crazy with earthly pleasures. As painful as it was to imagine returning to Earth in another mortal body all over again, we knew it had to be done.

The decision was made. We prepared for descent.

But you see, sending us to Earth in the same form would have been useless. We would not have evolved spiritually. Remembering who we were would have been achieved far too quickly. No, we had to devise a better plan,

one that might make us grow from emotional pain and suffering. This would make our lessons sink in much deeper.

We thus decided to let Spirit incarnate us as two parts; one masculine, and the other feminine. Each half would be a compliment to the other. Yin and yang. Six and nine. One and two. A and B.

Spirit's intention with creating the split was clear; by giving each gender qualities the other lacked, each half would continuously search for one another on Earth (well, except for some, but we will discuss that later). Neither gender would spend much time thinking on higher levels or being introspective. They would be too busy with romance and sex and subconsciously searching for their other half to bother with matters pertaining to Spirit.

Yes, here was the unspeakably painful separation of once perfect beings. From that day forward, men and women would be joined by Spirit, but divided in minds and bodies.

And that my friend, has been one of this planet's worst nightmares.

The Soulmate Shuffle

Humanity has played many silly games since it became divided into two genders. We placed ads in the paper, ran around and cheated, fell in and out of love, stole one another's partners, lied to get laid, got fit, rich and/or educated merely to attract the best possible partners, and so on. Day after day and hour after hour, we were obsessed with finding perfect mates.

As if these petty activities were not enough, there are all the side effects that occurred because of our shenanigans. Our failed love schemes gave birth to depressions, suicides, murders, diseases, and addictions. Like a worldwide dance, we have been swapping partners, trying each other out to see if we fit.

Well, life does not have to be that way.

Listen, everyone comes from the same source.

And everyone returns to the same source.

Who a person becomes involved with therefore does not really matter. Yes, there is indeed one person who is eternally meant for us, but ironically, the only way to truly reconnect with that person is to first realize how connected we are with everyone else. In the here and now, until the fateful day arrives when souls torn apart become fused back together as one, it is more important for us to see a little bit of that person in everyone we meet.

It is also important to realize that regardless of how perfect someone seems for us, compromise in some form will still need to be made. No one person fits us forever like the perfect glove. Why? We would find it boring, that is why. We would actually wind up going out of our way in creating conflict just to have some excitement.

Our Eternal Ties

Before the split in gender that occurred long ago, we were sexually androgynous beings. We were united in our

love for one another, our cosmic relationship sometimes appearing as a great lovemaking session, other times as affection or kindness. The magnitude of our love and respect for each other embraced the entire spectrum. That is how complete it was. This utopian ideal of wanting to be reunited with our soulmate will always exist. Reclaiming here in the Earth is not an unachievable dream. It is our fate. It will happen again.

The goal is also a little misleading.

Subscribing to the belief that we are made for one soul forever will inevitably lead to exclusion. Somewhere down the line, other souls who fall in love with us will wind up feeling left out, and that is not love's way. Love does not demand that anyone live in bubbles. Being in love with several people for different reasons at the same time can be immensely rewarding.

Still having trouble with the idea of a universal marriage? Dig up some childhood memories for insights.

Surely you must have explored yourself sexually in the company of friends in your youth. Perhaps you played "games" with each other. Unless you had a traumatic childhood experience or grew up in a conservative family, you were probably free of any shyness and guilt. Complete innocence is what you had. You just lived the fun for however long it lasted and when the time came to move on to new activities, that is what you did. No jealousies or hang-ups existed either, for life literally *was* fun and games.

That is the intended way of romantic love within the Universe. Every positive emotion and experience is to be lived fully, released, and relived later on. This behavior is deeply encoded within our spiritual blueprint and the more we continue fighting it, the more Spirit will try to slap us awake. Like the wind, Spirit does not fare well in a closed environment. Of course, considering how many sexually transmitted diseases and addictions are out there these days, the world's spiritual energy levels must become much higher before "free love" can return safely. Also, this kind of

behavior on our part would create havoc with current partners. We need to respect each other's boundaries.

If universal love between people and the Earth were understood and practiced, wars and killing would cease immediately. We would no longer feel jealousy, hatred, and envy for each other. We would realize how far back we go with even our worst enemies.

Certainly, one could refute all this talk about interconnectedness between souls by saying that if there is someone in the world who we absolutely cannot get along with, that the opposite must also be true; that there must exist one person we can totally get along with, and that this soul is the only one worth reconnecting with.

Yes, that can certainly be true - for a short period.

People are not static beings or robots. Each new moment changes them and shifts their emotions - showing us different facets of their personalities. Sometimes a person spends their whole life looking for that one perfect lover. Then one day they run into a likely candidate and

believe they have won the lottery. "Ah", they exclaim, "I finally found the one I want to be with forever!"

But after a few years, months, or weeks, these people might wake up to find themselves living with a different person. It is as if a stranger swooped in during the night and slipped a new person's character into the old one's body. This happens you know. Every day it happens.

Embrace immensity. Wanting to reconnect with your soulmate is a worthwhile goal, but realize that the entire Universe and everyone in it is your soulmate. Spiritually being in love with countless beings means that countless entities love you right back. What goes around comes around. You can still commit to one partner while remaining in love with the world.

Ok. That is enough about universal love. Let us move on and take advantage of this moment to closely observe a key player in our story: the apple.

The Passion Fruit

Have you ever wondered why the Bible's forbidden fruit is represented by the apple? Why the apple? Why not a papaya, orange, banana, or watermelon instead?

If you have some apples I would like for you to go and get one. A fruit knife too. And please make sure the apple you choose has a stem on it.

Ok. You are back. Place the apple near you and look away from it. In other words, simply exist beside the apple and see what happens.

Any problems here? No, none at all. Merely existing with an apple poses no problem whatsoever.

Now look at the apple. Admire its shiny texture and the way you think its skin would feel rubbing against your skin. Still no problem here, right? Right.

Go ahead, pick up the apple now and *caress* it. Looks like there is still no problem.

Now for the big leap.

Take the next step and bite into the apple. Do not worry, it is allowed. That is what the apple was made for. Go ahead and savor the juices as they kiss your tongue.

Mmmm! Delicious is it not? Does it surprise you to find that the "apple of your eye" has such wonderful taste?

If you are starved for pleasure, you may even want to take a big bite and devour the apple. So go ahead, munch in and let the experience take you to great heights. Moan and scream or release tears of joy if you want. Swing and gyrate your hips. Let your hair fly. Arch your back and growl. Climb the walls. Rip up the floors. Dance. Sing. Nobody has the right to dictate the way your apple should be enjoyed.

Be wise in your pleasure sprees though. If too many big bites are taken, progressively larger bites will be needed to attain identical pleasure levels. Then the apple will switch from being a pleasure to a drug. A means of escaping responsibility and reality is what it will become.

Soon after, you will forget how to enjoy smaller bites and the feel of the apple. Then you will forget how to simply look at it and exist with it.

Apples are a blessed food. Because of the pleasurable sensations they give our taste buds, perhaps they are amongst the most blessed foods of all. But as with many things in life, sometimes what is alluring can become dangerously addictive. One person's sweet nectar is often another's bitter poison.

The apple hides another secret; it is the fruit best resembling the human hermaphroditic reproductive system (where an individual possesses both male and female sexual organs). That is why the apple was chosen as the Bible's forbidden fruit. Let me illustrate this. Is the knife handy? Go ahead and slice the apple lengthwise just off the center.

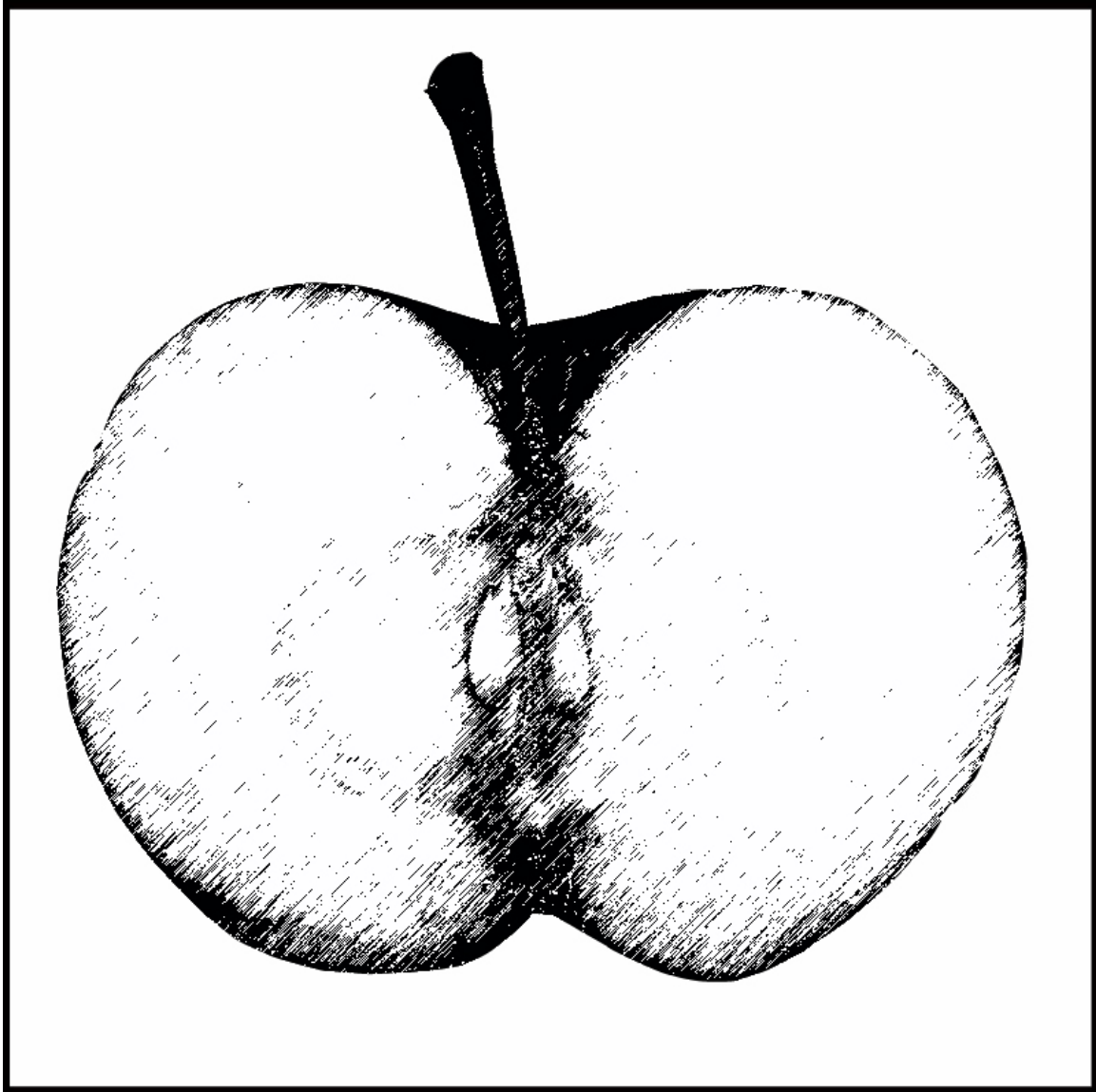

Figure 6. The Fruit of Temptation.

Looking at the apple, it is obvious that the apple represents S-E-X. We have the male penis (the apple's stem) through which flows the sperm (the sap). This comes

into the female vagina (the apple core) as the spermatozoa (apple seeds - i.e. the "seed" of man).

Spiritual leaders knew exactly what they were doing by representing the forbidden fruit as the apple. Few people back then talked publicly about human sexuality. Sacred knowledge had to be kept safe by hiding it in coded imagery. Apples became humanity's best scapegoat.

The dilemma of what gender to think of themselves as is so strong that for some, this confusion spills over into their relationships, creating imbalance. Surgical and hormonal treatments may help a scant few, but for most, being "intersexual" is a way of life.

We will speak more on hermaphroditism later. For now, let us examine another mysterious character.

The Rainbow Serpent

The human body is also a tree. This tree is the one referred to in the Book of Genesis as the tree of life.

How is that?

Well, our body's trunk is like the tree's trunk, our arms and ribs are the branches, and our crown chakra is much like the tree's own "crown". Even our vocabulary reflects our connection to trees when we say things like; "staying close to your *roots*", "turning over a new *leaf*", "not being able to see the *forest* for the *trees*", "my studies have *branched* out into new areas", "that was a *sappy* show", and "I'm *stumped*". Also recall the famous super thin fashion model named *Twiggy*.

In Buddhism, it is believed that an entity resides along the spine (the tree's trunk). Buddhists refer to it as being electrical, shedding light on why certain individuals who meditate and elevate themselves spiritually sometimes feel a "jolt" or "chill" in their backs. This force is represented by a serpent and is called Kundalini.

Explained simply, when Kundalini rests at the base of the spine, our chakras operate at low capacities. When the snake is aroused via meditative and breathing exercises, it rises up the spine and chakras. How evenly and steadily it

does so dictates how powerful the reopening of the chakras will be.

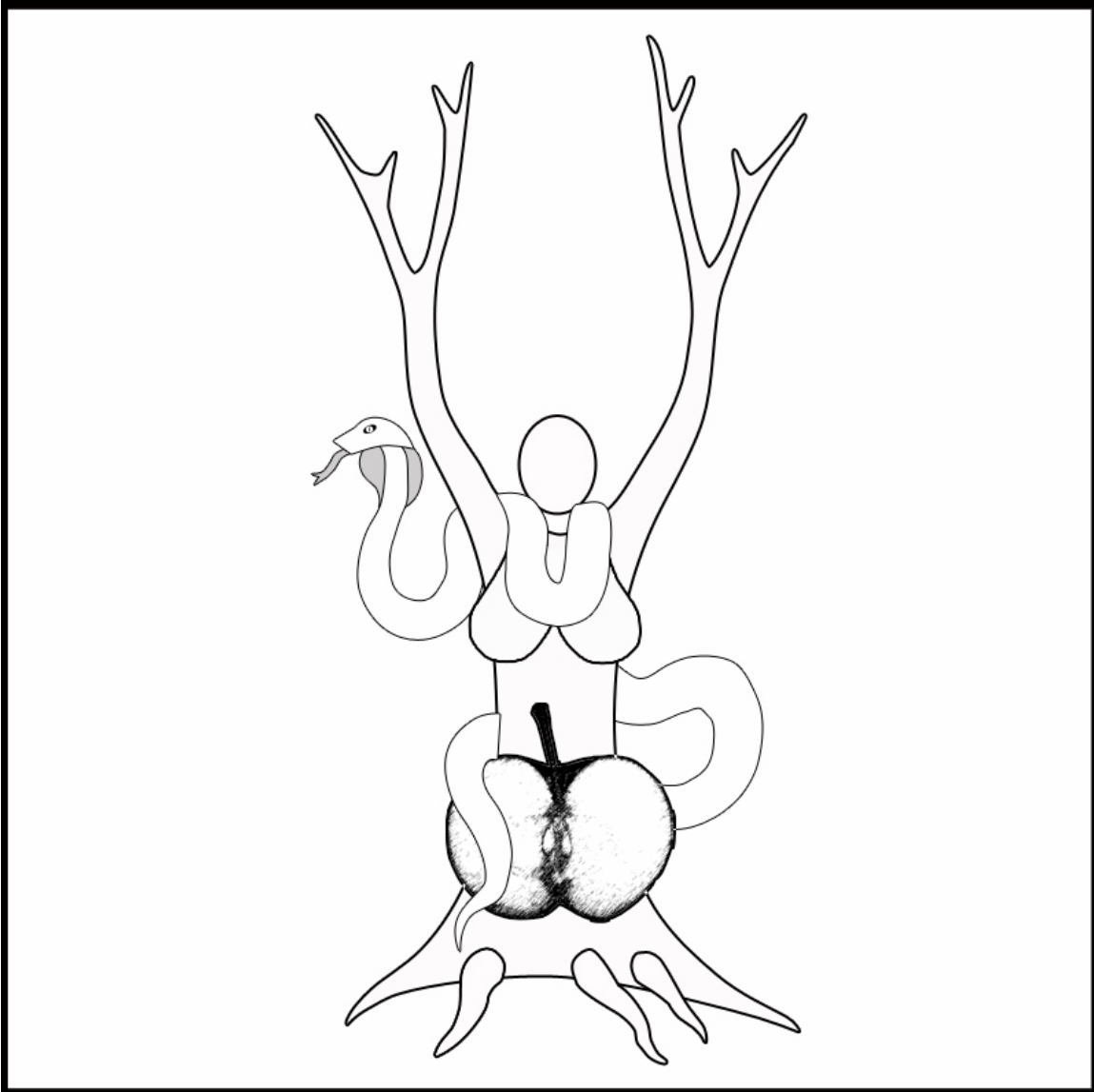

Figure 7. Kundalini Serpent on the Tree of Life.

When we first appeared in the Earth, Kundalini went all the way up the spine to and beyond our crown chakra.

Since we had not yet scattered our energies due to a wasteful power leakage (i.e. an unhealthy addiction to great sex), our sacred energies were reserved more for co-creating the natural world around us.

Then trouble loomed in.

We started fooling around and doing the wild thing with one another just a bit too often and in ways that incorporated much more lust than love. We went haywire with our creative juices and sent them flying all over the place.

Our worldwide polyamorous marriage and frequent lovemaking sessions thus degenerated into a series of massive full out orgies. Sure, these provided intense pleasures and were great while they lasted, but they also left us feeling drained and spiritually dissatisfied.

Of course, Kundalini responded to this shift in focus by slithering down our spines until finally reaching the base

chakras. Our ongoing obsession with sex led Kundalini to sneak around on its belly for the rest of its days.

Just like what happened to that wily old serpent in the Bible's Book of Genesis.

Our becoming stuck here as mortals was not part of Spirit's plan. Spirit loves sexuality and its use in expressing emotions. Erotic playtime is an essential part of both the physical and Spirit world. Sometimes it is gentle, quiet, and soothing. Other times it can be wild, messy, and raunchy. In Spirit's eyes, the many ways in which we choose to express ourselves erotically with one another are almost all the same - as long as these pleasures are in balance and in moderation.

Here in the original Earth, sharing our bodies was far from being evil. The Universe gave us sexuality as a gift. We just let ourselves go berserk with it, that is all.

A second reason for our fall from grace was our species' undying fascination with orgasms. Indeed, coming to a peak with our bodies felt so good we just could not bear

without it. For many males especially, sex went from a leisurely pleasure cruise with no fixed destination to a "wham-bam" business trip from point A to B.

Yes, by perpetually chasing the ultimate orgasm, it is little wonder that we became firmly embedded in these earthly organisms. The truth however is that there is not a single type of sexual orgasm here on this planet that will ever equal the intensity of the spiritual one we feel in the Light in the presence of all the other Spirits. In the afterlife, this total mind, body, and spirit orgasm is not merely sexual. It is the essence of who we truly are. It is what we were immersed in long before our Universe was even created, and it is what will continue to exist long after this reality and cosmos cease to exist.

This truth regarding our sexuality is by far the one that has been most used by cult leaders to ensnare their followers. The typical scenario is when charismatic individuals possessing a portion of divine truth lure young women or men into their circle. Because of ego and lack of

self-control, these leaders then proceed to take advantage of their entourage. It starts out innocently like touches, then gradually proceeds to kisses and finally blatant promiscuity until the whole thing comes crashing down for everyone and the inevitable media circus begins.

The mechanics of cult leadership is best understood by observing moths flying around a candle or light at night: one may think that the moths are trying to get to the light when in reality they are actually trying to get to the darkness on the other side. The candle is not really trying to illuminate the moth's paths, and the moths themselves are not really looking for spiritual enlightenment. Both parties are simply looking for a quick fix, and both ultimately get burned.

Before ending this chapter, it is probably a good idea to shed some light on another aspect of human eroticism; same sex relationships.

Love's AC/DC Nature

Let us start by taking a deeper look at why hermaphroditism exists at all.

As far as we know, every human being is born with a standard set of equipment; head, lungs, heart (a big necessity if you want to live for any amount of time here on Earth), stomach, and complete (or partially complete) spinal column. These are the basics. But the reproductive organs - why the variation? Why is gender such a fluctuating thing?

First off, every human fetus essentially starts out female. At some point, a switch takes place and some fetuses start developing a penis and testes. These become male.

Events occurring within the womb are not always so simple. Say that this baby (he? she?) is born an intersexual with male and female genitalia - a hermaphrodite. What happens then?

Another medical condition can afflict people: sexual androgyny. This condition is one where gender is not always

evident. Newly born children may display either barely a developed penis, vagina, or both. In some cases, sexually androgynous "men" have even grown breasts.

So, if being born as either a man or a woman is so important, why the variability? Why is there not a set, unwavering path firmly established within Nature that completely eliminates any possibility whatsoever that a human being could be born as anything but male or female?

In light of this, it appears that in the beginning, God created man and woman - as well as the means by which each could occasionally switch places.

Let us push the gender issue a little further (as if we have not already). The child is born as either male, female, both or none of either - whatever. Now, what guarantee do we have to say that this human being will be satisfied with its gender? Said another way, why do some individuals wish to change their sex? Even if they are content with their gender, why can they be heterosexual, homosexual, or bisexual? Why the variability? I mean, is Nature truly

screwing up here, or is there a deeper message that humanity just is not getting?

As far as hermaphroditism goes, it could be that the message given by little intersexual babies goes like this:

Hello Earth people. We know how polarized your thinking is and how you love to classify things into black or white, right or wrong. But look - a surprise comes your way; a soul fresh from the Light is born with both a penis and a vagina. Get the picture? Perhaps you're not all you thought yourselves to be. Maybe I'm a "throwback" to your original physical state. Maybe it would be wise to revamp your thinking and accept that sometimes people aren't neatly so categorized.

We were split apart as men and women for it was known that in order for us to reconnect with Spirit we would have to let go of fear, anger, and aggression. Once this was

achieved, we would be ready for a visit from our creators and perhaps a reunification with the one soulmate we were split apart from. Thus, at least for the greater majority of people here on Earth, man is meant to make love with a woman, and a woman is meant to make love to a man. A vagina receives a penis, and a penis probes a vagina. Yin to Yang, and Yang to Yin.

The coin's flip side is that Spirit also wants to make sure that people are subtly reminded of their original androgynous body states. The best way to achieve this was to incorporate a range of gender states and sexual preferences within human nature.

So, many Spirits born in Earth today as humans are playing little tricks on our uptight attitudes towards sexual love.

"Watch this," they are saying, "I'm going to incarnate where there's the most intolerance towards same sex romantic behavior and teach those people a lesson. I'll

become born with either both sexes at the same time or with a sexuality that'll shock the heck out of them!"

Certainly, the existence of androgyny, hermaphroditism, bisexuality, and homosexuality may be disturbing and offensive to most of us, but it also acts as a divine reminder that just because humanity consists of man and woman, it does not mean that intersexual relationships cannot happen.

Long ago, each dual gender person made love to other dual gender people. Since each person had both a penis and a vagina (or none of either if they wanted to appear so), this meant that each could alternate between being the giver or the receiver in lovemaking. In that kind of relating, the female side within each human being united with both the male and female sides within other humans. The same was true for the male side; it also made love with both female and male sides within other humans.

A prediction for the future; heterosexuality, homosexuality, and bisexuality will fuse into one sexuality. Just like it had been so long ago.

Much work needs to be done here on Earth before those days can return however. So much pain, noise, and confusion lives in the world today that only a miracle could erase yesterday's wounds.

Every human being is an adventurer - a courageous soul who willingly chooses to come to Earth to fulfill some type of important mission for humanity.

For us, back when Solar Spirit first split us in two and sent us back to Earth, adventures were far from being over.

In fact, they were just beginning.

AFTER THE FALL

The Path Of Most Resistance

Here we were; mortal, split in two genders, confused, lonely, and depressed. A fine mess.

Our getting stuck in the flesh meant having to endure the Sun's full force and suffering sunburns. Our bones, backs, and muscles ailed from standing. We were subject to arthritis, stomachaches, fevers, and ulcers. What a predicament.

Likewise, a growing rift between the logical and intuitive portions of our minds was taking place. Their bickering with one another became constant. Gone as well

were our shape shifting, mind reading, materializing and dematerializing abilities. Imperfect oral speech never fully conveying our innermost thoughts became our sole means of communication. Words failed us a lot back then, and still do today.

As for women and childbirth, since humans were now split in two and lost their shape shifting abilities, bringing children into the world became painful. And unlike how they were back in their original state prior to the fall, newborn babies were unable to physically communicate to adults their memories of what Spirit world was like. They were also helpless right from birth, whereas before they were much more physically independent and on an equal mental and emotional footing with adults.

The Rise of Civilizations

Over time, our bodies slowly adapted to the climates and lands we wandered in. These responded by changing in height, build, width, shape, and color.

Evolution then got an extra boost.

We were becoming such great survivors that more time could be devoted to deciphering the mysteries surrounding us. We could look at the ways in which our bodies worked for example, or why certain plants were more nutritious than others. With all this knowledge coming in, a sense of respect and reverence for the natural world returned. Before long, it was deemed essential that hunters speak with an animal's Spirit prior to hunting it. Also, certain days of the year, such as the solstices and equinoxes, were celebrated as sacred events.

New elements sprouted up all around us in these days. Making their first appearance were: more developed oral languages, agriculture, fishing with nets, and social hierarchies. Bit by bit, we were leaving our primitive selves behind. Individuals who had wandered aimlessly across the lands started living in groups, and these groups later formed tribes. Globally, we were beginning to reunite.

A funny thing happened to us on the path of evolution. We separated into two distinct societies, each one clearly distinct from the other.

The first group became characterized by a need for possessions and feeling in control over Nature. These bi-hearted individuals were constantly trying to out maneuver one another with wealth and cleverness. They also neglected to respect Earth's creatures. Animals and plants were killed in unnecessarily cruel ways and were not even asked for permission first or thanked after. The strength of these people's minds was that of *know how*. Their minds excelled on an intellectual level. Technology was to be their path.

The second group remained close to the Earth and evolved mostly on a spiritual level (though they also displayed remarkable stone technologies and architecture). These people valued simplicity and social relationships rather than clever inventions. Yet, they also contained the seeds of evil. Their sacred songs and rituals designed to

help keep creation and humans in balance became infected with petty jealousies and dogma - *Medicine wars*.

Time and time again, these two groups of humans have encountered one another and certainly not always under friendly circumstances. Individuals within both groups found that they shared common ground. They intermarried and several generations later the groups became less easily distinguishable. Throughout history, our cultures and languages have clashed and created new ones.

As the years rolled by and warlike tendencies became forgotten, a mind set was born where race, beliefs, and wealth no longer mattered. This is when utopian ideals of concern for fellow human beings and prosperity flooded the land. Respect for Mother Earth as well as highly developed technologies with ethics became the norm. We were finally living in the land of "milk and honey". Humanity's golden age had arrived.

Our languages in these societies were sophisticated. Architectural wonders such as temples, courts, gardens, and

palaces invaded the Earth's four corners. Children were mentally mature yet retained a love for playing. Adults kept a youthful mind and body well into the senior years and still showed the wisdom so characteristic of age. In every sense, these were highly advanced societies.

But again we began feeling the heat. Our societies started crumbling from within. The land of shared milk and honey somehow became the land of hoarded silk and money.

Another deadly trap held us within its jaws; we started trying to achieve with technology alone what was better achieved through Spirit. Rather than further develop our mind's long distance telepathic abilities for instance, we persisted in developing communications technologies instead. The mind's natural abilities gradually atrophied, with but a few people being consciously aware of how to use them.

As a result from being overly dependent on technology and life's material pleasures, we began getting lazy. Love

and respect were given low priority, as community leaders gradually became political tyrants. Petty disputes between heads of state escalated into wars between entire nations. These were proudly passed down with patriotism and ceremony from fathers to their sons.

Mother Earth witnessed our abhorrent behavior with one another and was enraged.

"Why don't my children wake up," she asked. "Don't they realize how interconnected they are and how beautiful life can be if they let it?!"

She consulted with the Solar Spirits in Heaven as to what action should be taken to bring a halt to the chaos. Both parties came to a consensus, deciding to teach us a lesson we would not soon forget.

Slowly, Mother Earth began to respond.

Wrath of Gaia

Mother Earth's skin rumbled and roared in the face of the deep. Huge tsunamis and hurricanes swept the coasts.

She unleashed her hot temper and coated the ground with ashes and lava. Plagues and diseases ravaged the poor and rich alike. Entire landmasses gradually sank into the oceans, disappearing without a trace.

After the storm came the calm.

The few survivors found themselves without homes, careers, wealth, social status, fame, possessions, and dignity. These were all ripped right out from beneath their feet. Few had seen the changes coming. The threat of having the world torn apart never even seemed to exist.

Down and down we fell, right back down to ignorance (what archaeologists commonly refer to as the age of prehistoric man). We wandered around on the globe learning how to take care of our physical bodies. We tasted this type of food, spit it out and remembered that it had a bad taste or effect, moving on to the next kind.

Our memories of previous lives in the Light and on Earth were no longer with us. Everything had to be learned from scratch. What was that strange ball of light that circled

the horizon? Was it the same one that came out at night? What was that elusive, transparent substance that the finned ones swam in and why could it not be held? Why did our bellies slowly go in and out? How far did the land and oceans stretch? When we were not busy taking care of our needs, everything was why this and why that.

Spirit and Earth put us right back at square one, and humanity's tiresome relearning cycles began all over again.

The Forgotten Nightmare

We reclaimed old haunts in the lands and shuffled around in small groups of people, fighting each other for whatever scraps of food we could find. Our bodies and faces underwent mutations for the emotional stresses suffered. We became unable once again to speak coherently. Back we went to all the aggressive and fearful behavior we had when we first fell from grace. We cried for many years following these catastrophes. Generations would pass before the traumatic memories could disappear.

Not all souls suffered this fate.

Some people were so spiritually advanced that they were "abducted" by Spirit prior to the disasters and brought to various Star systems and secret places within the Earth. They were encouraged again by Spirit to multiply. Others, having reached the highest spiritual levels attainable on Earth, simply let go of their physical selves and were brought back into the Light. Many plants and animals long thought to be extinct on Earth were brought to various Star systems throughout the galaxy and to this very day, exist in super abundant numbers.

In short, these tiring rises and falls of civilizations have occurred repeatedly for eons. Each new generation struggles to improve upon what the last leaves behind. Sometimes we advance and progress, more often however, we regress. As time marches on, nations tend to gain more intellect than wisdom.

During and after the disasters, wise leaders went forth and scattered sacred teachings across the Earth. They

searched for ways to preserve ancient teachings and thus came to hide them (where else?) in plain sight.

So we now have the Great Pyramid in Egypt, the temples of Central and South America, Stonehenge in England, various animal and geometrical carvings in the soils, cultural legends, stories and songs, and the Bible. We also have the stone figures on Easter Island, the medicine wheels of North America, the Ohio snake mound, Hopi sacred fire tablets, and the teachings of the Orient, India, Africa, Aboriginal Australia and Polynesia, etc. Each of these wonders represents a partial encyclopedia of the entire spectrum of human knowledge.

Many ancient cultures speak of a flood that overtook the Earth long ago, the Egyptians, Polynesians, Mayans, Chinese, Native Americans, Greeks and Babylonians are a few examples. The term "flood" however, masks what actually took place.

Here is what I mean.

A finite amount of water exists on this planet. Essentially, this means that the water that dinosaurs, saber toothed tigers and woolly mammoths drank long ago is the same liquid that we put into our bodies today. The only difference is that we tend to take it in as soda pop, coffee, beer, or commercially squeezed fruit juice.

With this in mind, even if rainfall occurred for a billion days straight, things would not be all that bad. Rising river, lake and stream levels would quickly flood surrounding land, stay for a few weeks or months, and evaporate or return to the oceans. Chaos would reign in the lower regions for a while, but nothing to justify trying to make elephants and mice coexist inside a huge wooden ark. Higher elevated towns and cities would be well out of harm's way.

Look at what happens during the wet season in Australia. When it rains there, it does not rain for just forty days and forty nights - the downpour lasts for five *months*. And the only flooding they see is the incredibly lush growth of tropical plant life.

You see, what actually happened long ago is that certain landmasses such as Atlantis and Lemuria (Atlantis' Pacific counterpart, sometimes referred to as Mu) gradually sank into the oceans. For the generations of people living far inland who saw great walls of water rushing in toward them and slowly engulfing everything in sight, this created the illusion of a flood. The survivors simply passed down to future generations what they witnessed.

The message to retain from these flood tales is that they remind us of what happens to a society when it thinks it is above spiritual and natural law. Disasters have taken place before, and could well occur again if we are not careful.

Actually, from a modern perspective, the tale of Noah's Ark could well have truth concealed within it. The physical impossibility of carrying two genders of billions of plant and animal species on a wooden boat may actually be a story about Atlanteans taking much smaller DNA samples of several key species with them aboard vessels similar to

today's modern aircraft instead. Like the flood tale, people witnessing this event may have found that hiding it within a tale about a man who builds a wooden ship was the only way for the story to live on into future generations.

The Earth Way: An Indigenous Perspective

So where do we go from here? How do we save the planet? Some would say that the clock must be turned back and that humans should live like people did back in the early eighteen hundreds, foregoing modern technologies and conveniences. Such action of course, is neither viable or desirable considering how difficult and physically challenging those times were for nearly every nation on the planet. Any direction taken at all must be forward. Too much has been endured and survived for us to go back and live in the past. And yet to march bravely into the future and disregard every warning sign given to us by nature and our own instincts would be equally unwise. A balance must be struck between ancient and modern ways of thinking.

For my people, awareness and respect for the natural world is imparted directly through our songs and ceremonies as well as the overall life philosophy. It is this inner state that prevents us, most of the time anyhow, from inflicting unnecessary cruelty upon the natural world. We do what is required to survive or keep the culture alive, but with awareness and respect. We prefer to deal out death one-on-one and under intimate circumstances rather than by either slow environmental degradation or relying upon plant and factory workers to do the job.

Every hunter's duty for example, regardless of their cultural background and if they are truly worthy of the title, is to put an animal through the least possible amount of pain and suffering once the shot is taken. If the animal is considered as a family member, as it should be, then showing the death or boasting about it on film or video becomes impossible to do. How can one glorify the death of a sibling? During the unaware phase I went through in my

teens however, I did do these things. Lesson quickly learned.

It is also vital to recognize that Mother Nature herself has become one sick lady - not only because of what we have done to her as a species but because of who she has allowed herself to become. What we call "the power and beauty" of Mother Nature is little more than a biological realm filled to the hilt with violence and brutality. "Happy" bird songs heard in the spring, for example, are often actually territorial cries sung between rivaling males, and the "peaceful" deer eating at field's edge is a nervous wreck forever on the lookout for predators. Even the "majestic" redwood in the coastal forest started out as an ambitious sapling fighting hard against others for space and sunlight. As for us, we are hardly different; sex and money run the world. In nature as well as in modern civilization, it is usually the perseverant "dog fighters" that make it to the top.

So even at the best of times, though she probably wishes it were not so, Mother Nature acts more often like a merciless bitch than a gentle friend. She *wants* to change and allow the serene woman within to take over, but we are holding her back.

The message is clear: if we change our ways, the Earth herself will change. We are the Earth, and she is us. If we raise our awareness levels, we can swing things around and turn the Earth into a truly peaceful and non-competitive realm. We can turn it back into the Light.

Our power as Earth's benevolent caretakers therefore, is directly tied in with our relationship to the planet's fauna and flora. We can literally change creature's habits and appearances simply by interacting with them. In other words, even the fiercest and most ruthless predator can be tamed - provided its new behavior is taught by us. I am not implying that anyone should go to the zoo and jump in with the lions and expect to have their faces licked. I am merely stating that over several generations, small and noticeable

changes within an animal's behavioral patterns and bodies will take place.

I hope you do not have trouble believing that human beings can impact animal behavior and evolution this strongly - the evidence is all around us. Traditional enemies such as dogs and cats, for example, have no trouble getting along when humans are there to act as mediators. And to everyone's amazement, grizzly bears and their trainers also get along on big budget film sets. And around the world, divers and researchers have already started to leave behind the shark cages and swim freely amongst the deadliest ocean predators. The sacred inner power that human beings wield over all of Earth's creatures is amazing.

Mother Nature's eyes are upon us. She is waiting for us to become kinder and less bloodthirsty (writing this is a bit difficult for me since I am a meat eater. Still, I have to write my truth as I see it). If humanity wishes to survive into the future, it must adopt a more peaceful lifestyle with nature's creatures, and with other people.

Once we stop murdering and creating wars, carnivores will gradually follow suit. As the planet's role models, humans can lead even the deadliest and most poisonous animals into re-becoming harmless, but the change must first begin with *you know who*. First we become kind towards each other, and the rest will follow. It really does all come down to us.

Choosing the Path

Here we are again in the present day - just another random spot on the Circle of Life. We are proud of our technologies and their capabilities. We have lasers, space stations and hundreds of satellites, computer technology, genetic manipulation and cloning, robotics, nanotechnology, and more. What on Earth would we do without them?

Well, as great as these technologies are, a disturbing question still needs to be asked: how much of all this high tech stuff we see around us is truly invented, and how much of it is simply being remembered? For if our technology is

invented rather than remembered, should its birth and development not have been much slower?

Is it not unreal how only our kind has achieved so much in the last fifty years alone, while animals have essentially remained the same for hundreds of thousands of years? What are the odds of this kind of speedy evolution ever occurring for another species if evolution is due to a cosmic throw of the dice? And if evolution *is* a dice throw, then why has another species not become as lucky as us?

The main reason technology is improving so fast is because it is nothing new. Our complex creations have been in the dark for eons, and now that we can afford to spend more time developing them, unlike our ancestors who were more preoccupied with survival, they are being brought back into the light. Progressing technologically is much like learning to ride a bicycle; no matter what length of time you go without riding one, you never forget. The skill quickly returns whenever you reapply yourself to the task. Right now just happens to be that time.

Our current technological dependency is much like when a person breaks a leg; the doctor prescribes rest and the use of crutches to enable the patient to get around for a while. When the leg heals up, the patient is told that they can ditch the crutches to walk on their own two legs again. Otherwise said, once global consciousness develops to the point where we can naturally duplicate our technology's capabilities, we will drop our high tech crutches - willingly.

To date, we have only tapped into barely ten percent of our potential, so we may as well get used to what will manifest as our creative powers start unleashing themselves. When it happens, we will finally realize that every form of technology surrounding us is almost nothing in comparison to what we are truly capable of. Remember, we are co-creators, and whatever is conceivable in the mind inevitably manifests in the physical world. This is one of the Universe's most fundamental laws.

We came here to experience life in a physical body and to co-create with The Great Mystery. One of our spiritual

challenges is not to just go back to Heaven or the Light - that would be a cop-out since everyone makes it back eventually. Our mission is to actually manifest that reality here. *This* place has to eventually become a mirror image of the reality that exists on the other side.

How then does one go about eliminating evil on the Earth and bringing about good? Well, for one, it helps to realize that everyone is on an individual journey. Rather than trying to force spiritual teachings down people's throats, it is often more productive and less confrontational to simply begin our own healing and lead by example. If you can do that for yourself and put up with negativity, foolishness and outright evil without judging or trying to "change" others, you are well on your way to spiritual enlightenment and changing the world. You will become a messiah unto yourself (and hopefully, in a very subtle way, unto others as well).

An exercise I have long used for my own growth is to envision a group of old and wise elders that emanate

wisdom and patience, and youthfulness. I picture these men and women wearing amused yet eerily all-knowing smiles on their faces, and all of them possessing the ability to see beyond time and space. Whenever I need a model to help me strive towards the type of person I would like to become, the vision of these people is there.

You are being asked to filter through what you have been taught in school regarding human origins. Dig deep within and feel your truths. Sure, science, with what it can decipher by means of its ever-evolving tools and vision, tells us that our kind came about as a result of random chance - by trial and error. And most religions try to persuade us that everything came about in an instant, almost by magic. Do these scenarios sound true to you? How about blending both together and injecting our own accountability into the mix for a change? Why not take a close look at our uniqueness in relation to the natural world and formulate something entirely new so that we can finally move ahead? Would that not make much more sense?

Telling it like it is

A Light exists far back in our global memory. This Light is where we come from. Indeed, each of us is a portion of this Light incarnate on Earth. Right here. Right now.

Do Star Beings exist throughout the Universe? Yes, of course they do. Is it possible to live with a body that is not subject to a finite life span? Yes. Does secret knowledge still remain to be discovered within the world? Oh yes - within the World's ancient books and monuments are teachings so powerful, so complete, and so intense that to rediscover them all at once would surely blow our minds to bits.

We stand at the edge of high drama within the Universe. The eleventh hour is upon us. Entire galaxies aware of our trials and tribulations are watching our every move. Wars in the Earth and in Heaven risk growing in size. Many lakes, rivers, and oceans are over fished and polluted. Entire forests are being clear-cut or burned. If the world were a stick of dynamite, we humans would see that we are

the ones holding the match only inches away. Sadly, humanity has become both hero and villain in its own saga.

Yes, we might revert back to "caveman mode" by destroying this civilization.

Or maybe we are tired of driving down a dead end road. Maybe we are ready to finally consult the road map given to us by Spirit. Perhaps we yearn to return to the age when humans were like Gods and Goddesses and life was lived on both Earth and in Spirit world. This is not about changing the world by forcing knowledge or awareness down people's throats, it is about critical mass and raising awareness on an individual level. It is about you. You are the hero.

Tell you what; if finding out more about human origins interests you, grab your jackets and passports and hop on the next flight with me. We are going on another adventure, this time to the cradle of humanity.

Our destination?

Northeast Africa!

EGYPT'S GREAT PYRAMID

Reactivating The Ancient Wonder

You are the Great Pyramid of Egypt. It is you in your perfect and intended state: sexually androgynous, astrologically whole, physically immortal, and all knowing. It represents you when you first appeared on Earth and were in full contact with Spirit. The Great Pyramid represents you as a god. The Pyramid is not a tomb. It is *life*.

Before we fully launch ourselves into the murky world of metaphysics and Pyramid related symbolism, the Great Pyramid of Egypt needs to be viewed from the right perspective. Heavy-duty insights will be presented in these

chapters, so our mental image of the monument had better be simple.

First of all, try not to think of the Great Pyramid as a stone structure. I know that sounds ridiculous since the Pyramid *is* a stone structure, but think of it as a spiritual symbol instead. If you allow yourself to get caught up in deciphering who the Great Pyramid's designer might have been or how it was built, you may go off on a tangent and be consumed by its physical nature, size, complex mathematical measurements and other data. Let go of all that. Bury it for now. Being obsessed or in love with the Great Pyramid itself is like being in love with a corpse. On its own, the Pyramid is nothing and means nothing. In order to glimpse its true purpose and meaning you have to look at it as a living symbol, an ideal for us to strive to achieve. If you can do that, you are on the right track.

See the structure as being much smaller as well, perhaps about the height of your own body - a size your mind's eye can easily manage. What I am stating here is

that had the Great Pyramid been built no higher than a camel's hump or even as small as a pebble in your outstretched hand, not an iota of its original purpose and meaning would have been lost. None. The architect knew that the sheer size of his finished project would make the structure difficult to destroy and impossible to steal. Those are virtually the only reasons why the Great Pyramid was built to be so big. I realize how this statement goes against nearly every Great Pyramid teaching and theory in existence, but there it is.

Thirdly (and this may be difficult for some due to academic training or strong past life connections with Egypt), I want you to temporarily set aside nearly everything you know about Egyptian Pyramids as well as Egyptian culture, art, lifestyle, philosophy, and religion. Until we are done, forget about all that and pretend it does not exist.

Why?

The Great Pyramid's blueprint and design did not originate with the ancient Egyptians. The ancient Egyptians hosted the finished end product on their soil to be sure, but the *idea* of the Pyramid came from elsewhere - and another time. Pyramids existed in older, more ancient times, and these blueprints were imported into other lands after this great civilization went under.

Lastly, use your intuition. Accept what your logical mind tells you when reading the following pages, but give priority to intuition. Let your feelings guide the way. The simpler something is, the harder it is to explain rationally, and knowledge concerning the Great Pyramid definitely falls in this category. The Pyramid's architect knew that in order to successfully keep the teachings secret for thousands of years, these had to appear complicated. They are actually straightforward enough that almost any layperson can understand them. Sleeping on these chapters a few times may be helpful, too. Let your dreams chat with you.

Ok, are we ready? Let us begin.

Our first insight into the Great Pyramid begins with a short course in astrology. As a matter of fact, astrology is the Pyramid's main building block. We can go no further if we refuse to look at the nature and workings of one of the oldest disciplines on Earth. I will be brief, I promise.

Language of the Stars

Human behavior may seem to have little to do with the movements of planets and stars, but let us remember that our bodies contain nearly every gas and mineral present within the solar system. If the Universe's base elements and chemicals dwell within us, why would we not in turn be affected by whatever affects the physical Universe?

Cosmic forces then, have much to do with the Sun and planets in our solar system. The study of the spiritual forces upon human behavior is called astrology.

Here are brief descriptions of the Zodiac's four elements of Earth, Water, Air, and Fire.

Earth

Taurus - The Bull

April 20th to May 21st

Ruled by Venus

Its symbol: ♉

Virgo - The Virgin

August 23rd to September 23rd

Ruled by Mercury

Its symbol: ♍

Capricorn - The Goat

December 21st to January 20th

Ruled by Saturn

Its symbol: ♄

Earth people are like the element itself: down to Earth. Soil rarely flames up with fire's enthusiasm or holds the intense, emotional depths of water. Neither is Earth inclined

to become abstract like air. No, Earth is always right beneath our feet, silently but firmly keeping us grounded.

Usually, Earth people possess a deep sense of responsibility and concern for social etiquette and moral behavior. This reveals itself most fully in their interactions with people. Earth people are the Zodiac's diplomats. Because of their steadfastness, they usually fret and concern themselves over the slightest details when undertaking new ventures or activities.

Emotionally, Earth people are as comforting as the big rock beside the river we used to go relax beside. Stable, practical, and dependable. These words are often used to describe these people.

Air

Gemini - The Twins

May 21st to June 21st

Ruled by Mercury

Its symbol: ♊

Libra - The Scales

September 23rd to October 23rd

Ruled by Venus

Its symbol: ♎

Aquarius - The Water Bearer

January 20th to February 19th

Ruled by Uranus

Its symbol: ♒

Air does not need permission to go where it wants, it does so freely by nature. Straight into and through Fire, Earth, Water, and even Air itself. Air people are breezy.

They are also highly acute in their thought processes and speech. Unfortunately, they can appear somewhat distant or flirtatious with their emotions. They interact with humanity mostly on an intellectual and mental wavelength rather than a physical or emotional one. Air people are

usually easy to get along with and have a "live and let live" attitude. Being gregarious, it is not unusual for them to have twice as many friends (or are they more like good acquaintances?) than other people. As a rule, they do not enjoy drama (unless conflicting planetary influences dictate otherwise). Because of their excellent public relations skills, Air people are often called upon to act as arbitrators in helping to bring about group consensus. Air people value everyone for their inherent worth and demand freedom of thought and speech.

Air plays a vital role in the Earth and our bodies. Air ensures that the fire within Mother Earth's core will not fizzle out. Oxygen fills her waters to provide creatures and plants with air, enabling them to breathe.

Water

Cancer - The Crab

June 21st to July 21st

Ruled by the Moon

Its symbol: ☊

Scorpio - The Scorpion (or Eagle, depending on how evolved the soul's personality is)

October 23rd to November 22nd

Ruled by Pluto

Its symbol: ♏

Pisces - The Fish

February 19th to March 20th

Ruled by Neptune

Its symbol: ♛

The next time you are at the movies, pay attention during the emotional scenes and watch for tears running down people's faces. Chances are that the first people you will notice crying will be Water people. They cannot help it. Water people are the feelers of the Zodiac. On calm days when the water is smooth, do not be fooled. Still waters run deep. Grab your lifejacket if your swimming abilities are not up to par. You might need it.

Some Water people love to go with the flow while others have focus and direction and show their intense power with their eyes alone. In many cases, Water people need no words to communicate. They pick up other's feelings and thoughts just by being with them. They feel deeply for each soul they come in contact with and demonstrate strong self-sacrificial qualities. Whereas a Fire or Air sign might simply help someone out and go on their merry way, Water people spend time with that individual.

Water can appear in a less soothing manner as well; when treated unfairly, Water people will either bawl their

hearts out or display some furious temper tantrums. If you are in the same boat as a Water person and it starts rocking, hang on and ride it out. Trust that when calm skies reappear and the wind dies down, the love and friendship you originally had with these delicate souls will still be intact.

Our bodies are composed of nearly 80% water, and this element permeates the Earth as well. Without water, life on this planet would shrivel up under the Sun.

Fire

Aries - The Ram

March 20th to April 20th

Ruled by Mars

Its symbol: ♈

Leo - The Lion

July 22nd to August 23rd

Ruled by the Sun

Its symbol: ♋

Sagittarius - The Archer

November 22nd to December 21st

Ruled by Jupiter

Its symbol: ♐

Fire shows its power by appearing suddenly from nowhere. Strike two flint pieces together for example, and a spark results. Where was the spark before? Inside the stones. All that was needed to bring it forth was a decision to start something. Initiative and enthusiasm. That is Fire.

So, just like that spark, Fire people are usually "all fired up" about something. Their enthusiasm could be due to their involvement in a new project, personal hobby, love interest - whatever. Regardless of their latest endeavor, Fire people will tell the entire world about it. With them, depression never lasts.

Fire is inside us and keeps our body temperature at 98.6 degrees F. The fire element also burns inside Mother Earth's core and her lover, the Sun.

#

Well, there we have it; a good, basic description of the Zodiac's four elements. We had to go through with that in order for what is coming up to make sense.

The Astrological Pyramid

Let us perform an experiment.

In your mind's eye, draw a twelve-hour clock face, replacing the hours with the twelve Zodiac signs. Place these in the same order that they occur on an astrological calendar year. We will start with Aries at one o'clock, Taurus at two o'clock, Gemini at three, Cancer at four, Leo at five, and so on until we arrive with Pisces at twelve o'clock, ok? To facilitate this, here are the astrological signs again and each one's corresponding "hours" and symbols.

- 1) 1 o'clock: ♈ (Aries)
- 2) 2 o'clock: ♉ (Taurus)
- 3) 3 o'clock: ♊ (Gemini)
- 4) 4 o'clock: ♋ (Cancer)
- 5) 5 o'clock: ♌ (Leo)
- 6) 6 o'clock: ♍ (Virgo)
- 7) 7 o'clock: ♎ (Libra)
- 8) 8 o'clock: ♏ (Scorpio)
- 9) 9 o'clock: ♐ (Sagittarius)
- 10) 10 o'clock: ♑ (Capricorn)
- 11) 11 o'clock: ♒ (Aquarius)
- 12) 12 o'clock: ♓ (Pisces)

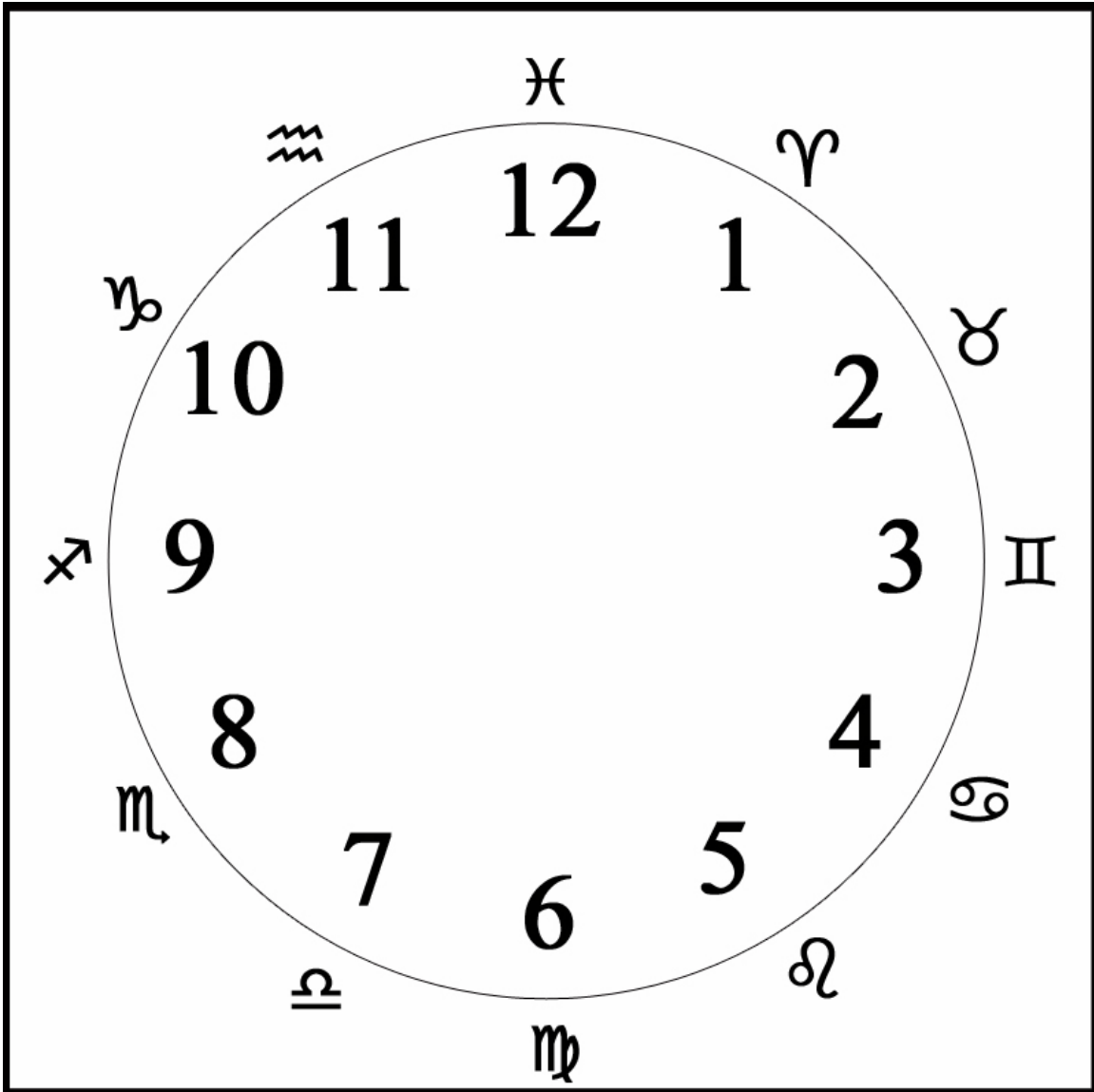

Figure 8. The Astrological Clock Face.

The process of understanding how the Great Pyramid symbolizes us now begins.

Within our clock face, connect the signs contained within each element to each other. In other words, make straight lines connecting the Fire signs (Aries, Leo, and Sagittarius) together. Do the same with Air (Gemini, Libra, Aquarius), Water (Cancer, Scorpio, Pisces), and Earth (Taurus, Virgo, Capricorn). Upon completing this, you will find that you've created four perfectly equilateral triangles. A twelve-point star.

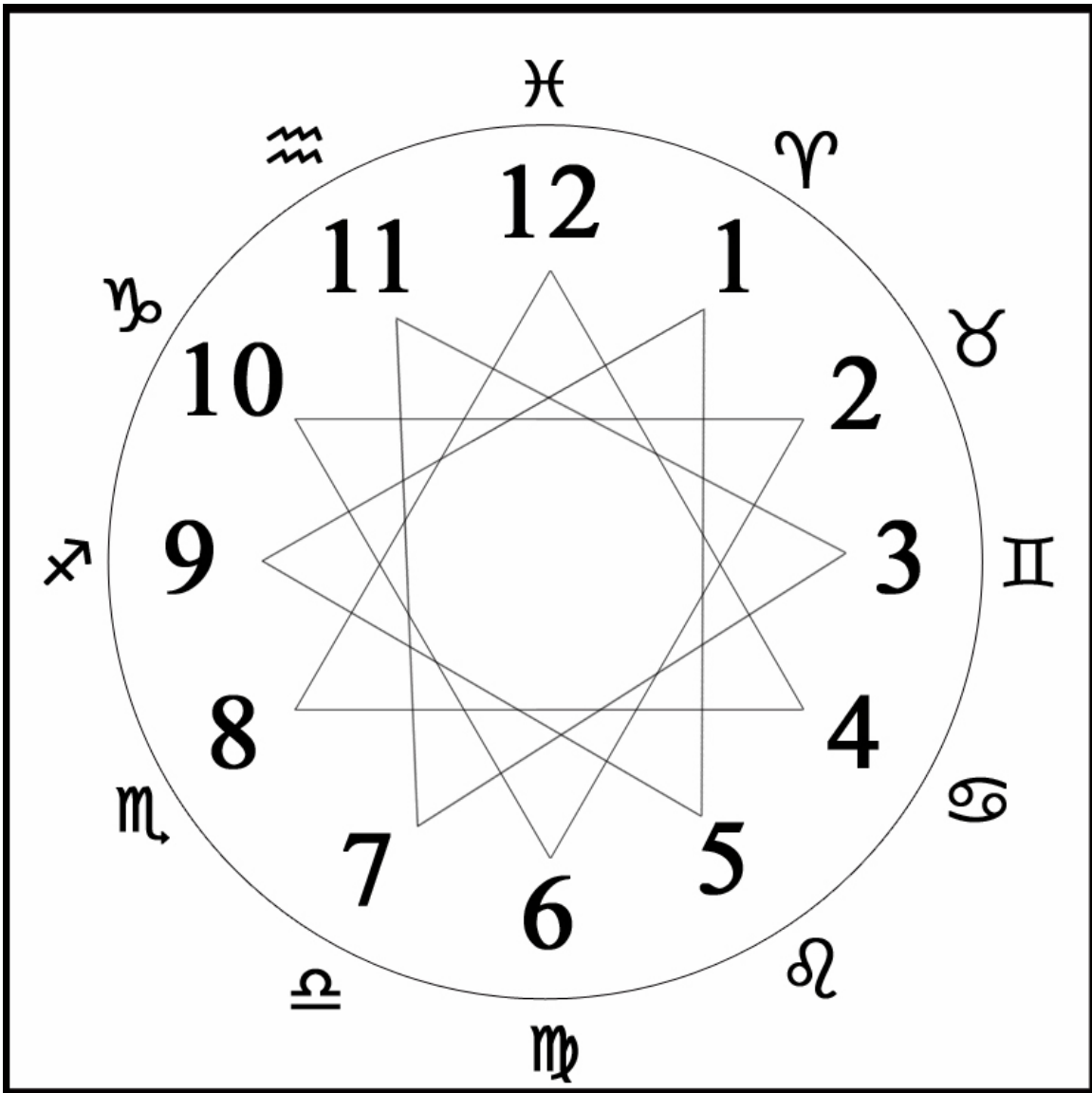

Figure 9. A twelve-Point Star.

If we proceed on to the next illustrations and separate these triangles and lean them up together (so that these touch at the top), we achieve an astrological Pyramid identical in degrees of angle to those of the Great Pyramid of

Egypt (51 degrees between the apex or summit, and the base).

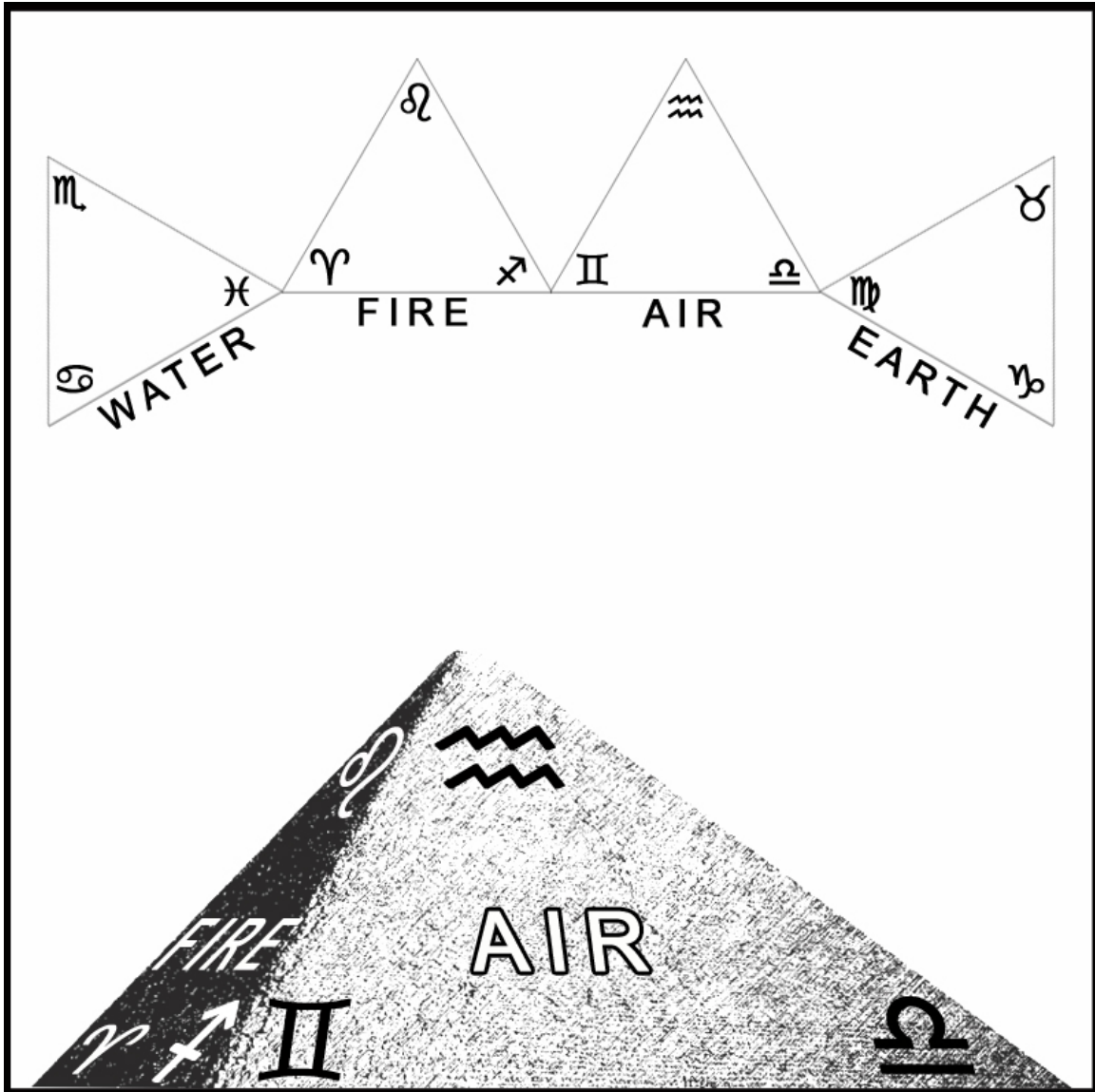

Figure 10. The Astrological Pyramid (side view).

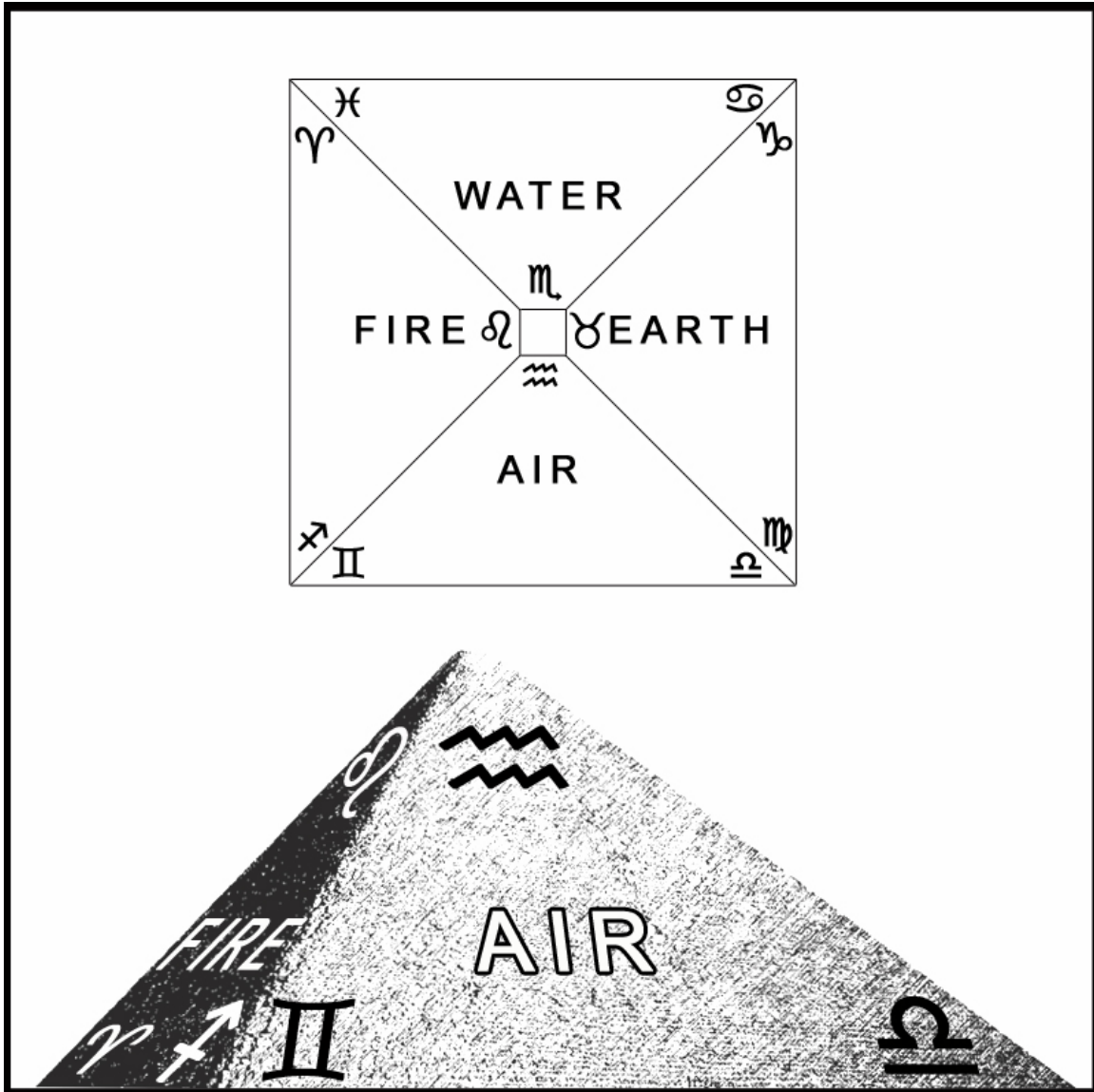

Figure 11. The Astrological Pyramid (top view).

Understanding this first insight into the Great Pyramid is simple: like us, it contains the twelve Zodiac signs as well as the four elements - in one body. In other words, rather than being one sign only such as Sagittarius or Gemini, we

are actually meant to be all twelve signs at the same time. As our character was above in Heaven, so it was below on Earth. Being astrologically whole, we got along well with anyone and everyone.

People who undergo near death experiences often find their personalities changing dramatically when they return from the Light. Feeling reborn, they find themselves acting in direct opposition to the way their Zodiac sign dictates they should. Before long, the previous sign's characteristics are completely erased and a newer, more holistic one sets in. The sudden change in character completely bewilders their closest friends and loved ones.

In the Light, the petty self-imposed rules of "I can only get along with such and such a sign" no longer apply. People reborn in the Light almost become...well, perfect.

The Thirteenth Sign

Jesus' decision to chum around with twelve other people was not by accident; he did it in order to convey a

message. Author Linda Goodman believed that each one of Jesus' disciples represented one of the twelve Zodiac signs. Jesus was thus able to absorb the best of each disciple's qualities into his own character and let go of their negative traits, thereby embodying the entire Zodiac within himself and becoming...the thirteenth sign.⁴ So the disciples, as well as being Jesus' students, were also his teachers.

As great as Jesus' mission was and continues to be, let us be realistic. Going on a robe and sandal wearing pilgrimage around the country today with twelve other people and eating fish and bread just so one can become an enlightened master is extremist thinking. The message would not come across anymore. Nobody would go for it (except for those plagued by the notion that they can be given what they already have). Neighbors would quickly call the tactical police units, thinking a cult was operating in the area. Everyone would hide the virgins, lambs, and chickens. A less dramatic way exists to become the thirteenth sign.

1 Linda Goodman, LINDA GOODMAN'S STAR SIGNS, ST. MARTIN'S GRIFFIN, New York, NY, 1987 p. 220

Just do what all of these great teachers did; learn all that you can about spirituality and open up to Spirit.

In other words, free your mind (without narcotics preferably) and see life in new ways. Heal your life's wounds and let go of hate and fear. Release your inhibitions and your possession's hold on you. Be curious. Let it all go. Whatever values and beliefs keep coming back are probably right for you.

Ok, so by reconnecting with Spirit, we become like a thirteenth sign. Splendid.

How does this tie in with the Great Pyramid?

More Surprises Unsealed

You know, the greatest man made structure in the world should be complete where it counts the most - on top. Curiously enough however, it is not. The Great Pyramid lacks a crowning touch. No capstone is on the Pyramid, just a square limestone platform.

That the Great Pyramid might have been built without a capstone on purpose makes sense. Relating our bodies again with the Great Pyramid, the capstone is indeed present, but it was intended to be invisible (i.e. "ethereal").

This theory sounds insane and not worth the paper it is printed on, unless you take a good look at the back of an American dollar bill. Only with the help of this monetary prop does the truth about the Pyramid's "missing" capstone appear in full view. The Great Seal of the United States is loaded with insight. America's founders had more than a passing interest in Egyptian lore. They relied heavily upon the powers of ancient knowledge to successfully build their country.

Let us analyze the Great Seal more in depth.

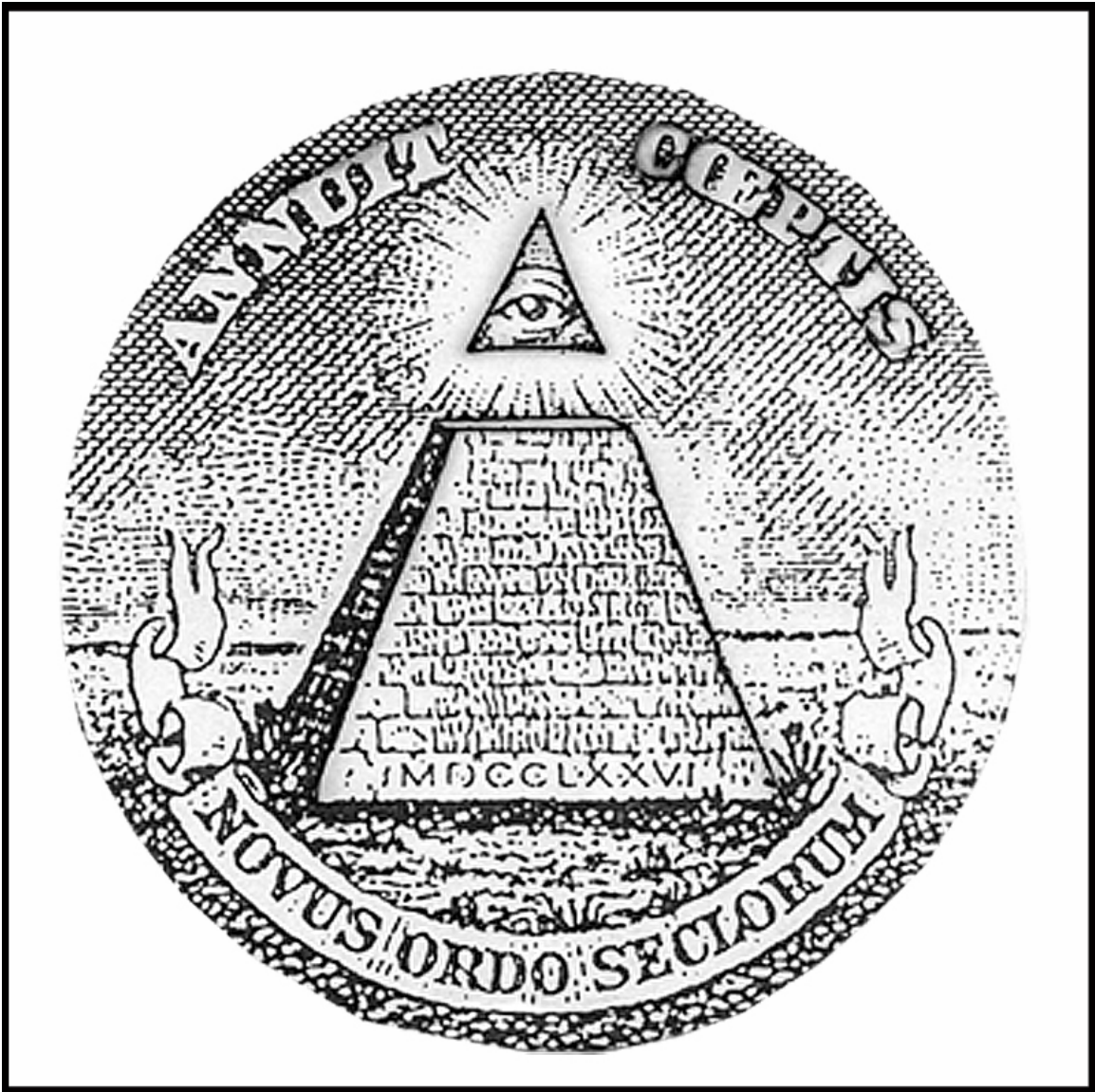

Figure 12a. The Great Seal of the United States.



Figure 12b. The Great Seal of the United States (reverse side).

Looking at the Great Seal, one can clearly see what appears like a luminous (or fiery) capstone hovering over the Pyramid with a mysterious looking "eye" inside of it.

The Pyramid within the Great Seal of the United States symbolizes the earthly human being. You. Me. Everyone around us. The fiery capstone on the other hand, represents Spirit and the Messiah within. The "eye" on the capstone represents our third eye (mind's eye, eye of Ra or Horus - it is all the same language). The Great Seal of the United States is a coded image symbolizing the human/Spirit relationship.

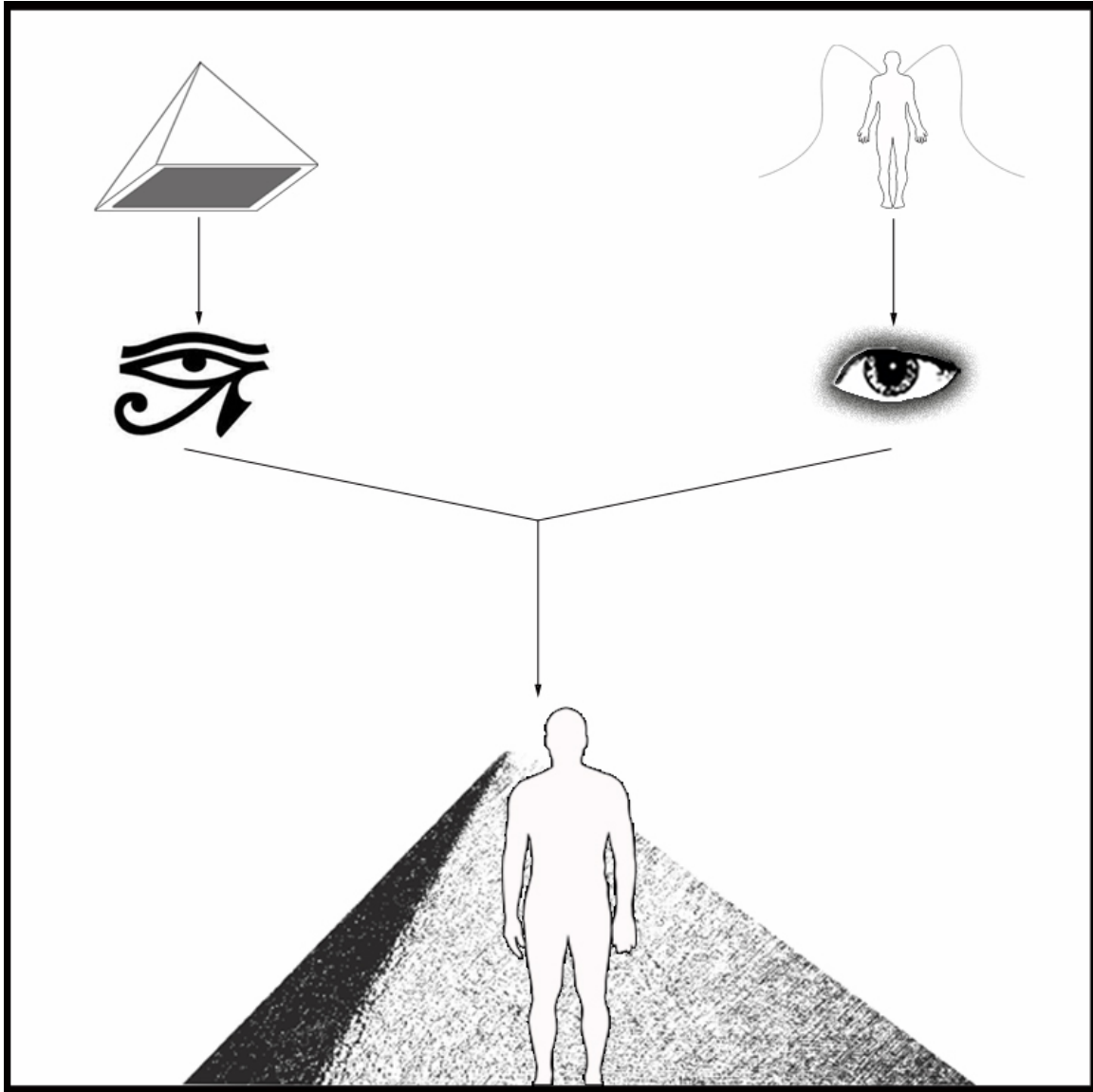

Figure 13. Human Being/Pyramid Relationship.

America's forefathers did not stop there. As if to further guard sacred teachings, they put in more clever

insights into the Great Seal - especially ones concerning the idea of an all-encompassing thirteenth Zodiac sign.

Exactly thirteen vertical levels of stone masonry make up the Great Seal's Pyramid, for instance. And written in small letters over the Pyramid, one can count thirteen letters within the Latin words *Annuit Coeptis* (He Favors Our Undertakings). On the reverse side of the seal, we find a Bald Eagle that grasps thirteen arrows in its right talon.

In the left talon, the Eagle grasps an olive branch upon which, if one squints and counts again, has thirteen leaves and thirteen olive berries growing on it. Shifting our focus to the banner in front of the Eagle's chest, one finds thirteen vertical light and dark stripes. Within the phrase *E. Pluribus Unum* (From Many Into One - again, in Latin) are 13 letters. And above the Eagle's head, in what looks like a solar symbol are thirteen stars.

Now, some would say that the number thirteen repeated so often within the Great Seal signifies America's

original thirteen founding colonies rather than any kind of relationship with astrology or Egypt's Great Pyramid.

Could be. It is possible.

Still, why did America's founders decide to go with a Pyramid? Why not a mountain instead? Or a castle, temple, church, or statue for that matter? Why a Pyramid? Besides that, why is the Great Seal's Pyramid missing a physical capstone just like the one in Egypt? And why does the "eye" within the Seal's design neatly correlate with third eye and the Egyptian eye of Ra and Horus? A little too coincidental, would you not say?

To further demonstrate America's obsession with Egyptian architecture, witness the striking similarity between the Washington Monument in Washington D.C. and the huge obelisks that were often erected in pairs at the doors of Egyptian temples. Aside for size, little differentiates them. If America can take the structural blueprint of an Egyptian obelisk and plant its clone on U.S. soil, surely they are

equally capable of drawing a revamped image of the Great Pyramid and stamping it on currency.

America's forefathers designed the Seal the way they did for a purpose, and chance had nothing to do with it. God does not gamble with the Universe any more than founders do with nations.

OK. So far we have looked at how astrology, the four elements and third eye are all incorporated into the Pyramid's design. Hang on, for the surprises do not end here. Slithering its way into our awareness now is discovering how the Kundalini also dwells within the structure.

The Kundalini

At first glance, no direct link appears to exist between Egypt's Great Pyramid and the Kundalini. If we want to see how a Pyramid structure displays the Kundalini, we have to travel clear across the world to Mexico, specifically to the Yucatan Peninsula and the Kukulcan Pyramid at Chichen Itza.

Our Mayan brothers and sisters in Central America are keepers of an ancient prophecy. Their ancestors believed that Quetzalcoatl, their teacher and older brother, would one day return in the form of a feathered serpent to teach and lead them.

From an engineering view at least, this prophecy has certainly come true. To this day, on the fall and spring equinoxes, September 22nd/23rd and March 21st/22nd, multitudes gather at the Kukulcan Pyramid to witness what happens when the Sun shines down upon the temple: a long shadow resembling a serpent comes slithering up and down the entire length of the Pyramid's 91 steps.

Implementing a serpent element within the Native American Pyramid's design was done deliberately. The architect knew that this was an excellent way to portray the kundalini. The prophecy of a feathered serpent could equally be re-interpreted in modern times to mean a *snake* with wings, which again could well be code language for the Kundalini "flying" up and down our spines.

The fact that the Mexican Pyramids exist halfway around the world does not mean that they are disconnected from the teachings of Egypt's Great Pyramid. All peoples of the world originally had access to the same sacred knowledge regarding our origins and spiritual nature. The *Rainbow Serpent* of our Australian Aborigines brethren could also be seen as another representation of kundalini.

Perhaps these and similar teachings foretell of a time when dormant spiritual forces within every human being will one day reawake.

Well, on second thought, there is a way that the ancient Egyptians portrayed the kundalini, but it is through symbolism rather than direct correlation with the Pyramid. The goddess Wadjet from lower Egypt, for example, was depicted as a winged Cobra (a snake with wings).

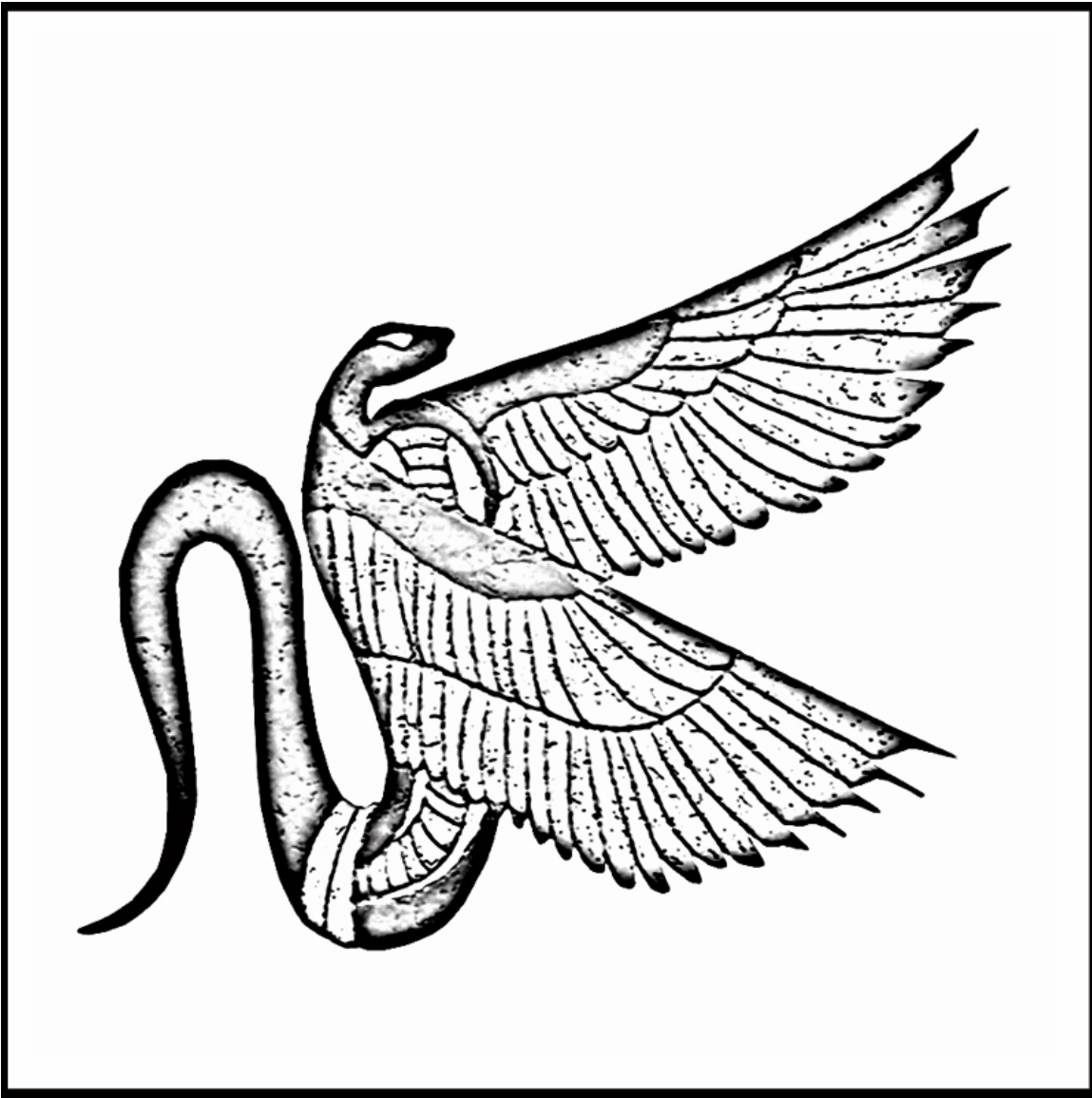

Figure 14. The Goddess Wadjet.

Often shown either crawling or in-flight, she was also regularly portrayed as the Uraeus, a serpent emblem symbolizing royalty and divine authority protruding from the

forehead (as seen on the famous mask of King Tutankhamun and within lot of Egyptian artwork).



Figure 15. The Serpent in the Forehead.

Do you see the correlation? The Kundalini lives within our bodies and flies back and forth between us and the

Great Spirit. Wadjet also dwelled within the Egyptian's bodies and protected her hosts from harm.

So although the Egyptians themselves never directly incorporated the Kundalini within the Great Pyramid's design, the related symbolism between the Kundalini and Wadjet certainly lends the open-minded observer to believe that there may be a strong connection between the two.

So you see, we have a lot in common with the Great Pyramid. If one idea is retained from this chapter, let it be this one.

Each and every one of us is a human Pyramid.

You are the Pyramid.

Now, what do you say we find out more about what this little marvel can do?

CRYSTAL SECRETS

The Human Pyramid's Awesome Potential

This is a true story. The tale's main characters are two good friends of mine who also happen to be mother and daughter. I will name them "Angie" and "Katherine". Both witnessed a marvelous happening several years ago demonstrating one of humanity's fantastic abilities.

Angie was but six years old the day she walked into her mother's kitchen, crying and her feet dragging across the floor.

"What's wrong honey?" Katherine asked.

"It's Matt mum, he keeps teasing me and saying how he has all the power and the force behind him and how I have none! I want power too mum. Why can't I have any?!? WAAAAAH!"

Now, Matt is Angie's older brother and my childhood friend. Matt was a *Star Wars* fanatic. Whenever my family and I would visit their place, all that Matt ever talked about to me was Luke Skywalker this and Luke Skywalker that.

Anyhow, like most big brothers, Matt enjoyed flexing his gray matter. His teasing struck a sensitive chord on this particular day however. Angie admired her big brother so much that it hurt her to think she could not be like him. As usual, Katherine was called to the rescue.

"Don't cry honey, you have powers too," she said. "You know what," she added, "as a matter of fact, you have even more power than Don!" Angie's sniffing came to a stop as she pondered her mother's words. Her cute little frown shifted to raised eyebrows and a smile.

"Really?" She exclaimed. "You mean I have power too, like Matt? I can do anything he can?" Obviously, Angie was looking for a confirmation.

"Of course you can, honey," Katherine reassured her. "You can do and be anything you want. Anything!"

Angie glanced out from the kitchen at an empty glass on the dining room table that stood at least fifteen feet away. Matt had probably worked himself into a frenzy earlier while restoring freedom to the galaxy and had forgotten to put it into the dishwasher. Angie's mental gears revved and she decided to test her mother's words; "Mum, you mean that if I can do anything I want, that I can pretend my finger is a gun and shoot that glass from here?"

"Sure you can honey!" Katherine replied. Why not go along with it, she must have thought, it can't do any harm.

"Ok then," Angie said while drawing her digital weapon, "BANG!"

The glass shattered.

Now all of this is only what I remember both of them telling me several years later, so I didn't actually witness seeing the glass break myself. I sure would have loved to see their faces though. They must have looked hilarious.

Angie was the first to react.

"MOM! MOM! DID YOU SEE THAT?! I SHOT THAT GLASS AND IT EXPLODED!," she yelled excitedly while letting her "gun" point at her mother.

"HEY," Katherine shrieked back in horror, "YOU KEEP THAT THING AWAY FROM ME!" There was no way she was going to let herself get zapped by a nine year olds' index finger.

From that day on, Angie never doubted that she had as much of the "force" as Matt. Angie had proven once and for all that she had the magic touch.

#

I love that little story. I also shared it with you of course, to make a point.

Why do you suppose the glass broke like that? I doubt that Katherine or Angie went to the trouble of putting a tiny explosive charge underneath the glass to trick each other. And it was not an unseen projectile coming from Matt's bag of tricks that hit the glass either. No one from outside fired off a round into the house. One could attribute the event to resonance and simply say that Angie was able to shatter the glass because of the pitch and tonality of her voice, but the chance of that happening requires perfect acoustics (and a lot of luck).

No, it was more than this. When the human spirit is under stress and must perform, extraordinary things happen. The glass shattered because of something that happened within Angie.

What broke the glass was intensely channeled spiritual energy backed by faith. Pure, innocent faith as displayed by a child. Angie's entire being was the gun, faith was the gunpowder, and her spirit was the bullet. Totally trusting in her mother's words, six-year old Angie was able to make a

drinking glass burst into pieces from over fifteen feet away with her index finger.

Ok. That's all great. But concretely speaking, how did Angie manage to do it? How did she bust the glass?

Enter the magical powers of crystals.

Our Crystal Powers

Crystals are found everywhere in the world. They are in the snow in the form of snowflakes and the ice of frozen lakes, rivers, ponds, oceans, and so on. Likewise in the ground itself; crystals are found growing in caves, and in sand.

The entire Earth then, by virtue of her crystallized nature, could be said to be a giant crystal herself. And since our bodies and those of animals and plants contain elements that eventually form crystals as well, "liquefied" crystals permeate us, too. We are then, Liquid Crystal Display beings and whatever crystals do, we can, too.

In basic terms, crystals - in whatever forms they exist in - are receivers and emitters of energy. That is what they do.

Every crystal then, possesses an axis or line of transmission through which whatever type of energy the crystal is subjected to travels. In a single pointed crystal for example, energy coming into the crystal is received through the bottom, is transformed and gains in power as it reaches the end where it is shot through the point itself. This energy field is the one so often referred to and used in crystal healing therapy.

The energy a crystal receives can be sound and radio frequencies, brain waves, emotions, sights, smells, and so on. Depending on how we reconfigure our inner crystals through prayer, meditation, and intention, the end result of how the energy emits from us will vary.

A good example of this is the laser beam.

When we absolutely need to get something done, we become like a laser. By configuring our inner crystals via

intent, our emitted actions and words "shoot out" from us in bringing about the wanted results.

Another power of the spiritual laser beam can be demonstrated by how we use our minds and free will during times of depression and sickness.

When we are feeling ill, we can choose to fix the situation in a variety of ways: we can choose to either heal ourselves with the power of love and positive thinking, or we can mope around and rely on the use of powerful drugs and medicines. If we give the former healing method priority, the Creator's Light energy can come into our crystallized bodies and "zap" the illness. Against the awesome power of the spiritual laser beam, little resists. Deadly diseases such as cancer, arthritis, aids, leukemia and the rest become sitting ducks. Sounds pretty wild I know, but it is true.

People diagnosed with terminal illnesses sometimes suddenly find themselves showing no signs or symptoms of their illness. This is known in the medical world as "spontaneous remission". But essentially, whatever it is

called, this type of healing is simply Spirit in action. No need for antibiotics in the Spirit world. Spirit has all the good medicine you need.

As human crystal receivers and emitters, it is important that we control the types of energy we expose ourselves to. What, or who, we hang around with will eventually be assimilated into us and emitted later on. In other words, what we think, hear, or see eventually becomes what we put out by words or actions--either psychologically, psychically or physically. What we want or focus on, we get. How we see ourselves becoming, we become. Like begets alike, "*as a person thinketh, so shall they be*".

Comparing ourselves with a radio, it is easy to see how by "switching" channels, by "tuning" in to good thoughts can produce fantastic effects for us as well as for those around us.

Let us elaborate.

If we listen to a particular song repeatedly for instance, we find that even after the radio is shut off, the song still

plays inside our head. We may even hum the melody all day long and not realize it until later on. The reason is simple; as a human crystal receiver, we absorbed the song's energy and it made an impression upon our minds. We "channeled" it into ourselves. You see? A radio's crystal receives radio waves, and our brain's crystals receive brain waves. The same language applies.

Now there is nothing wrong with absorbing the energy around us. If hearing a song evokes peaceful images and emotions within our psyche, that is great. We will be that much more in tune with ourselves and Spirit. But if the song contains offensive hate lyrics, that is the kind of energy we may emit later on.

So whether something is sensed, touched, smelled, heard, thought, or voiced, its "energy" comes into our body's crystals, is imprinted on the mind and soul, and is emitted.

That is why it is important not to dwell upon wrong doings others inflict upon us. Feeling the anger is okay, and

we can defend ourselves or stand our ground, but we must then let it go. Kind of like turning our cheek and even offering the other one if that is what it takes to neutralize negativity.

If, on the other hand, we obey our lower natures and counter blow for blow, each portion of our negative energy gets received by others. This becomes amplified by their desire for revenge, and this goes out from them and affects everyone else in greater amounts. So what begins small can later become huge. The process is a ripple effect.

You see? That is how world wars get started. Someone gets angry and cannot release his rage in a non-threatening manner. He nails some unsuspecting soul and this person wants to get even - maybe on his wife and kids. The rage continues growing from there, eventually infecting entire nations.

These widening ripples of cause and effect do not distinguish between good and bad. They only ask that we watch what we put out there for others to pick up upon.

Everything affects everything. Nothing and no one exists in an isolated bubble.

The nice part of this is that we can "program" our inner crystals too. How? Well, the easiest way to do this is by flooding the mind, positive brainwashing if you will, with powerful imagery, scents and sounds - whatever it takes to make us think deeply about life and love. You want to change your life? Change your thinking by flooding yourself with positive influences and thoughts. Stop hanging around negative people if all they want to do is leech off of you and your energy. Do not watch the news if it makes you sad. Spend some meditative time every day speaking and listening to your best friend; yourself. Post little happy notes and images all over the house until you actually become that reality. Do not worry if it seems fake at first. It will, but sooner or later the illusion will stick, and you will feel and be better off for it.

Additionally, all forms of knowledge within the Universe can be "channeled" by anyone provided they "tune in" to it-- just like a radio.

The power of attraction is magnificent. You want something, and provided that what you want wants you too, it will always come to you. This is true for knowledge, material things, and yes, even people.

Most people have at least one person in their lives they connect with. People like this are said to be on the same wavelengths. These people might even find themselves finishing each other's sentences or picking up each other's thoughts. The connections between them are that strong.

We have just described telepathy: knowing each other's thoughts by resonating with them. This process is amplified if the joining of minds evolves into a joining of hearts and bodies, which is why it is so important to carefully choose whom we are intimate with. Here is what I mean.

If you have done a lot of healing and spiritual energy work on yourself, you are probably well aware of the effect you have on people - especially if they have done very little of their own emotional healing. When they look into your eyes, it is like they somehow become seduced. Well, in a sense, they are. Their Spirit is communing "eye to eye" with yours.

Sometimes our inner light shines so brightly that others are drawn to it sexually - even though attracting that kind of attention is not our intention. No need to feel guilty; it is natural and happens all the time. Just be aware of this power and respect it.

This especially holds true for us men. Our penises must be securely locked away during all spiritual interactions. Let the person officially designated as your lover liberate your tool. If you do not currently have a lover, refrain from preying on others who may be younger or not quite as far in their evolution and development. Either deal with your sexual anxiety by yourself or abstain.

Young or inexperienced people who have awakened to their spiritual power have to be doubly focused in intent and purpose. If too many physical liberties are taken with others, disastrous outcomes can occur. Treading in slippery and forbidden territory is a great way to ruin friendships.

Occasionally sharing yourself on a casual basis is fine however, if you are single (or have a very open marriage) and encounter souls during your travels who share your own spiritual strengths and levels of self-awareness (as long as safe sex practices are used of course). Chances are though that if you are "up there" in your energies and most of your spiritual work is performed in the trenches, you will meet very few of these people. In some places on this Earth, they seem almost absent at times. Whether it is in the corporate office or a third world country, the spiritual battlefield is everywhere these days.

Sex starts in the mind and Spirit - even when it is casual. If prospective bed partners do not match up on spiritual and life philosophies, do not be too anxious to drop

your drawers. You are way better off satisfying yourself or flirting with a good book instead. Sorry, but that is just the way it is.

Establishing certain physical boundaries between us and those who may not have done as much work on themselves is necessary, otherwise, our spiritual energies that we worked so hard to acquire risk being diminished.

In other words, if you bed someone with major issues while you have already worked, or are working, on your own, the person you sleep with will stroll off rejuvenated by your spiritual energy while you will feel temporarily drained. Your spiritual work will lose power too, and others will notice it. You will start losing credibility.

Remember this: as human crystal "receivers", we pick up on whatever emotions others harbor inside them - especially during sex. We become more like them, and they, like us. If someone you are sleeping with has a lot of emotional baggage, it is likely that you will take some of

that negative energy in and emit it later on yourself. Be watchful.

This is why those who are excessively promiscuous have some of the lowest spiritual energy levels around; they dive blindly into other people's trash bins. They may feel great after their exploits, but they walk away from the experiences covered with other peoples' emotional trash and do not even know it. Their activities also open doorways to the spiritworld where less evolved spirits can watch and even participate in the debauchery by entering participant's bodies. This ugly occurrence is amplified if drugs and alcohol are present.

Yuck.

So is repressing our sexual natures the solution? Hardly. Any true visual artist, dancer, and singer knows that the source of creativity itself is raw and uncensored sexual energy. It is without doubt the most intense and powerful force in the entire Universe. Sexuality is there to be harnessed and used to create. The issue becomes one of

balance and not allowing this energy to burn or consume us. That is what it is all about.

The world's true spiritual masters often seem to lead sexless lives or be without desire. In truth, it is not that these souls repress their sexuality; they express their sensual natures to their fullest on a daily basis. They simply choose to do so without the limiting and often emotionally murky conditions and filters brought on by involving the physical body and mind. The masters, teachers, and gurus of the world understand people's fascination and need for sexual expression, but have dedicated themselves early in their lives to being able to work with it as a spiritual force rather than a purely physical one.

A true master also knows that regardless of what people do with one another sexually here in the Earth, carnal pleasures cannot equal what is to be had in the Afterlife, so why fuss or obsess over them? In that sense, to a master anyhow, it is better to simply dedicate one's self to studying spiritual matters and helping others.

So whatever properties and abilities crystals possess, we can replicate with the power of our own minds. As crystals within a DVD or CD ROM record data, so do our minds register thoughts, emotions, and memories. As a calculator figures out equations, so can we do the math with our brains. Facsimile machines send images on paper thousands of miles away. We can also think deeply about distant people and communicate with "projected" mental images, like how you might be thinking of a relative and all of a sudden you get a phone call from them. In other words, crystal abilities residing within television sets, computers, telephones, watches, and radios can be mirrored and even surpassed by us and our own minds. Period.

Well. All this talk about the power of crystals is interesting, but how does it relate with the Great Pyramid?

Let us attend a little family reunion to find out.

An Identical Twin

Of all the types of formations displayed by crystals, the one of most interest to us is the octahedron. The octahedron consists of two Pyramids placed back to back, or top and bottom. Octahedrons are particularly relevant to this chapter simply because of how their shape correlate with the Great Pyramid.

Each half of an octahedral crystal you see, regardless of its host mineral, has the same angles between its slopes and base as that of the Great Pyramid: 51 degrees.

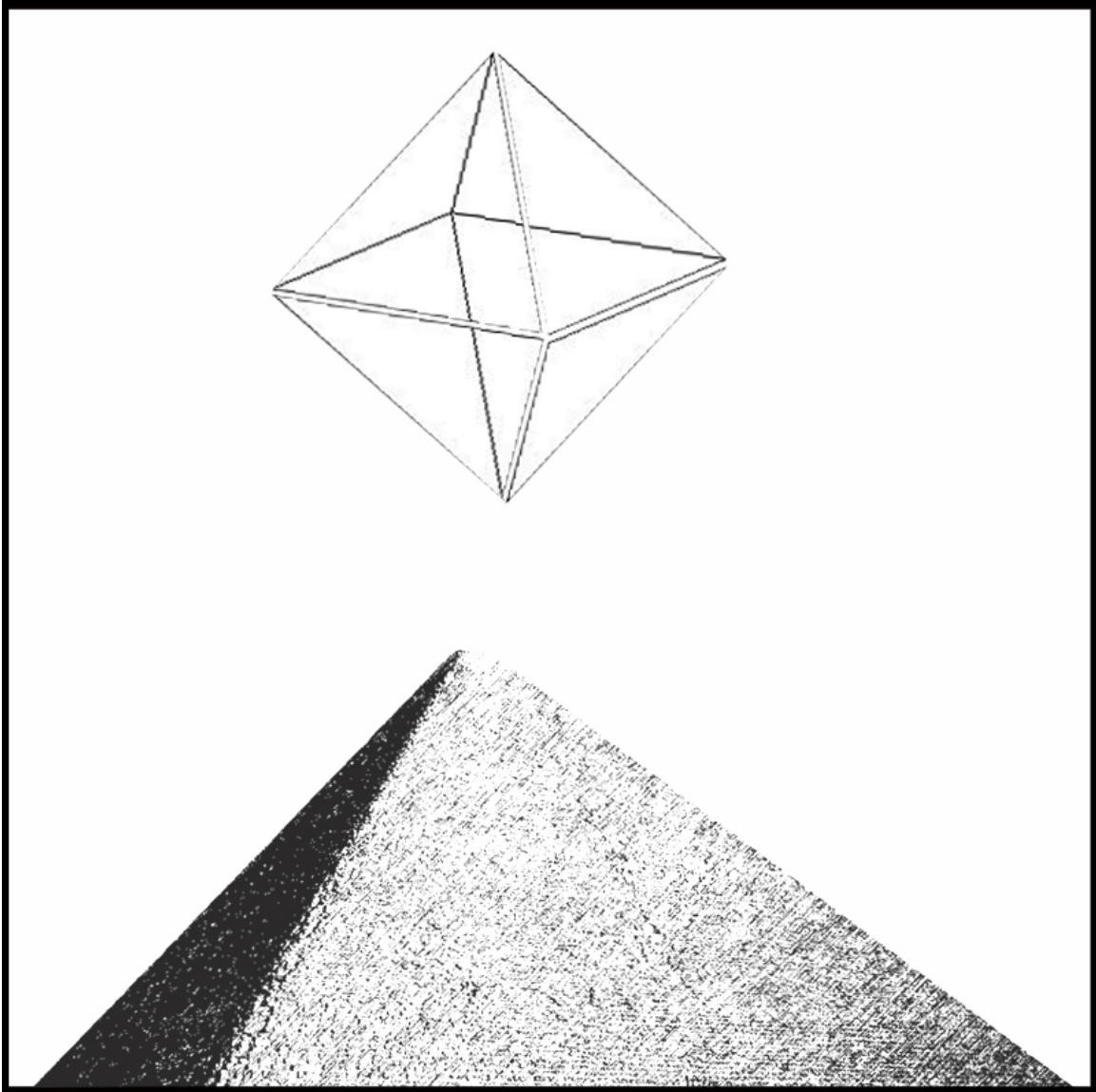

Figure 16. Angles of the Great Pyramid and those of an octahedron Crystal.

Hmmm...an octahedral crystal and our Great Pyramid, each one sharing the same angles. Hold on. A connection dwells here. Let us see. Could the popular expression "As it

is above, so it is below" apply to the Great Pyramid of Egypt? Was the structure designed to imply that an identical one dwells beneath it? Probably. And yet although in all likelihood the Pyramid does not have a twin existing beneath it physically, the idea here is that it was designed to *give* this impression.

The Great Pyramid of Egypt, with only half of it visible, symbolizes a gigantic octahedral crystal.

Do you recall the light and prism experiment done back in high school? The one where we took a bright light beam and shone it into a clear crystal prism? What did we see on the other side on the wall or screen? Colors. We saw colors. Six of them. And they were: red, orange, yellow, green, blue, violet. Ultraviolet - the seventh color - was hidden from our physical eyes, but present nonetheless. The Great Pyramid, built as an oversize octahedral crystal, symbolically contains the rainbow light spectrum - our chakras.

Romance in the Pyramid

Millions of people worldwide have or have had an enduring fascination and admiration for Egypt's Great Pyramid. Whether the passion for the structure has to do with trying to figure out who its architect was or how it was built, you would be hard pressed to find *someone* on the face of the planet who does not have an opinion on what it is and why it is there. What could possibly live within the Pyramid that attracts people so?

Put on your fedora and grab a bullwhip because we are now going to explore inside the Pyramid - or more specifically, within the King and Queen's chambers.

Unlike other Pyramids and temples in Egypt, the Great Pyramid has never been proven to contain anything but stale air. Nada. Zilch. No sacred treasures or maps to fame or fortune. No hieroglyphics or mummies either. Just an empty sarcophagus in the King's chamber, a few narrow tunnels, and that is it.

What if the King and Queens' chambers have an entirely different meaning and purpose than what has been proposed to date by conventional archaeology? What if the reason why these chambers were built into the structure has to do with human gender and sexuality? In other words, what if the simple fact that the Great Pyramid of Egypt has a King and Queen's chamber implies that, since the structure itself is the human body and contains male and female elements, we were once dual gendered ourselves?

Depending on whose literary works one reads, absolutely precise measurements pertaining to the volume in cubic inches of the King and Queen's chambers vary. Some say the chambers occupy so many million cubic inches in volume, others say that much. Don't worry, as the issue is rather trivial. The chamber's proportion's true meanings are easily grasped if one looks at the underlying message. Just for clarity's sake, let us pick two literary sources for their measurements. Each one is going to be greatly

simplified anyhow, but knowing near exact numbers to begin with will help.

In *The Authorship and Message of the Great Pyramid*¹, Julian T. Gray quotes the Queen's chamber as being 9,963,200 CPI in volume (CPI stands for (Cubic Pyramid Inch). One Pyramid inch equals 1.00106 British and American) inches.

Another author by the name of Rodolfo Benavides, in *Dramatic Prophecies of the Great Pyramid*², gives the King's chamber measurements as being 413 PI (length) X 206 PI (width) X 228 PI (height). When multiplied together, this gives us a grand total of 19,397,784 CPI, a figure slightly two times more than that of the Queen's chamber.

To simplify, this means that the volume of the King's chamber is double that of the Queen's. In other words,

1. *The Authorship and Message of the Great Pyramid*, 1953, Julian T. Gray, E. Steinmann & Co., OH (From the Tim Hunkler Homepage (http://www.hunkler.com/pyramids/pyramid_symbolism.html)).

2. *Dramatic Prophecies of the Great Pyramid*. 44th ed. 2nd English translation. 1974 by Rodolfo Benavides. (From the Tim Hunkler Homepage (http://www.hunkler.com/pyramids/pyramid_symbolism.html))

when it comes to physical size and strength, the King is two times the Queen.

Let us step aside for a moment and share the seat of power with our female counterparts. As we will soon find out through the revelations of an ancient science, women are really the ones dominating the monarchy. Here comes a demonstration of female power via Chaldean numerology.

The Numbers of Love

Chaldean Hebrew knowledge is close to Egyptian lore both spiritually and geographically. Chaldea was once part of southern Mesopotamia (now Iraq), which is relatively near the Great Pyramid and the Nile (just a few days travel away really). Chaldean numerology is the science studying the esoteric meanings hidden within the vibrations of numbers and names. The Great Pyramid contains numerology for a reason.

Here then, is the Chaldean Hebrew numerological alphabet:

A = 1	M = 4	Y = 1
B = 2	N = 5	Z = 7
C = 3	O = 7	
D = 4	P = 8	
E = 5	Q = 1	
F = 8	R = 2	
G = 3	S = 3	
H = 5	T = 4	
I = 1	U = 6	
J = 1	V = 6	
K = 2	W = 6	
L = 3	X = 5	

As you can see, every letter in the alphabet corresponds to a certain number. You may also have observed that no letter is assigned to the number nine. According to legend, the Chaldeans thought that the number nine could not be assigned to any one letter for it was God's number and thus was too sacred to be written.

So, let us take the letters within the words "King" and "Queen", write their corresponding numbers alongside them, and see what we come up with:

$$\text{KING} = 2+1+5+3$$

$$\text{QUEEN} = 1+6+5+5+5$$

Adding the numbers within the word "King", we have a total of 11. The number 11 is a master number in most all numerology systems and rules abstract thought.

Adding up the Queen's numbers, we come to a total of 22, which is another master number in numerology, and exactly double the King's 11. The number 22 rules both the abstract and physical realms. In many numerology systems, 22 is called the "master builder".

Now, hopefully the following words regarding the Queen will not confuse us too much. She is quite a complex lady. While several equally valid ways of interpreting these numbers' presence within the Great Pyramid exist, we will outline just one of them.

The Queen's 22 is actually made up of two 11s added together. In other words, the Queen is an 11-11. These two numbers symbolize the Queen's (and every woman's) dual nature: that of being a mother as well as a lover. Saint and swinger. Queen and princess. Wise advisor and wild child. So you see, a woman is not just one person, but two people at the same time.

Ladies, please excuse me for a moment. The men and I need to discuss this further.

Okay guys, have you ever wondered how our wives or girlfriends can go from being sensuous kittens one minute to enraged wildcats five minutes later? Or why they exude total self-assurance one day and are inconsolable the next?

I mean it fellows, let us take a good look at the loves in our lives. Watch them as they examine business reports, iron clothes, talk on the phone, feed the kids, and read a novel all at the same time. How in the world can they take on so much at once?

Simple.

Their spiritual energy is different from ours.

Spirit knows that women are capable of greater emotional and physical endurance than men. So Spirit gave our other halves a sort of double personality to juggle, with each one of these two personalities containing several people. This sheds insight into why they can swing from being caretakers, mothers, administrators, lovers, saints, and corporate go-getters at a moment's notice. Women are different than you and I in the sense that we tend to focus our attention in one area (or a few at the most). Male tunnel vision is both our best and worst asset. Women's mental focus is more like a light bulb than a laser; they are able to see and do many things at once.

For our other halves, harmoniously balancing all these identities without too much conflict can be frustrating. That is why they need us to relate with where they are coming from. If we realize this female duality and try to flow with it, we will appear less shocked when mood swings occur. We will be able to take whatever comes like a man rather than

escaping the scene by going fishing or jacking up the volume with the remote. And on days when they feel they need to be isolated from us, we will pick up on the clues easier and will not pester them with our demands or questions about where our shoes are.

Ok. Let us get back to numerology here.

We were saying that the King is double the Queen's physical size, while the Queen is double her man in the language of numbers. He has the size and muscular strength. She has the strength of the soul. Their strengths and weaknesses are equal (albeit in different areas).



Figure 17. The King and Queen's Energies within the Pyramid.

Let us ponder the implications here.

Perhaps clearer insight could be gained by asking two little riddles:

- 1) In the presence of love, what is one plus one?
- 2) According to creationists, woman came from man's body. If this is so, then what gender was man when woman was still a part of him?

I suppose any answer given could be seen as correct.

Personally, I am going to reply one (and two) for the first riddle, and both genders (and no gender at the same time) for the second one. Why? Because the King and Queen are so much a part of one another that they are one being. They are a King and Queen living within one body, the Pyramid. In other words, they are a hermaphrodite, or an androgynous being - however you wish to see it.

Exactly like how we were when we first appeared in the Earth.

In that glorious state, we had several gifts: shape shifting, telepathy, the ability to "beam" ourselves into other dimensions, appear of different ages, and so on.

But perhaps none of these gifts were cherished as much as the one we had when we were in full physical union with those we loved; the gift of eternal love and life.

The famed fountain of youth.

The living Christ within.

When any human relationship is blessed with Spirit, it defies the effects of time. When was the last time you checked your watch during the throes of passion? When lover's minds, Spirit, and bodies are as one, everything comes alive. Leaves on the trees are greener, everyday sounds become melodies, foods taste richer, and time...loses...significance.

This could be why elements placed within the Great Pyramid, a gigantic living crystal, do not decompose. Time's effects upon physical matter cannot stand against the power of love.

So you see, wrapping up corpses and placing them in giant stone structures does not provide the soul with eternal life. We already are spiritually immortal, so mummification

does not do anything special. The Great Pyramid is just a big classroom workbook built in stone. That is all it is. It was built long ago to remind us of our abilities and of our true nature. It is a roadmap for our spiritual evolution.

You are the Pyramid. You do not need to go to Egypt to study it. Travel there if you feel you need to, but do not be surprised if you feel let down by the experience. The Great Pyramid has survived earthquakes, sandstorms and wars but it will not be there forever. It is the very last remaining Wonder of the Ancient World and one day it will be gone. We had better start viewing it from a different angle before that happens.

If you want to know all that there is to know about the Great Pyramid of Egypt, start by studying yourself.

You are the Pyramid.

Do you now see what the Great Pyramid is then? The ancient structure is a magnificent coded encyclopedia - a living testament to our greatness as human beings. Our potential, history, and destiny are represented by it. The

Great Pyramid foretells of a time when we will fully reconnect with Spirit and receive the gift of physical immortality.

Again, gaining eternal life by wrapping ourselves up in cloth like the Pharaohs is unnecessary. Immortality (for as long as Spirit decides to keep us on Earth) is a much easier ideal to achieve. Both the Egyptian as well as the human Pyramid have something powerful in common.

They can only become operational if they are invested with the powers of Faith, Hope, and Love. Without these emotions placed inside them, their awesome powers shut down.

Accepting the idea of physical immortality must seem ungodly for many. Whether we are 119 years young or nine-years old, the saying "one life is all you get" bombards us constantly. Society at large promotes it, and so does the entertainment industry. In our modern culture, dying has become more than an accepted consequence of aging; it has become profitable. Our entire planetary system is built upon

it. Regardless of whether it is for big budget movies, funeral parlors, flower shops, insurance agencies, and so on, death is good for business. And as long as cash keeps pouring in, because of the hold that death has on people's minds, we are comfortable in keeping it that way.

Sigh.

We do not have to die and leave this body behind forever. At some point in the future, our bodies will be different than how they are now. These will be thought of by nearly everyone as consisting of tangible light. Once this new consciousness and awareness occurs, we will be able to come and go, between Heaven and Earth, as we please.

If doubts regarding physical immortality still exist, let us explore the world of ancient mathematics and see what it has to say about how life originally was here on Earth. After reading what follows, we might realize once and for all that the Pyramid's architects had more knowledge about us and our bodies than was ever deemed imaginable.

π

Three Point One Four, The Little Ratio

With So Much More.

Pi.

The ratio representing the numerical relationship between a circle's circumference and its diameter.

By taking the sum total of measurement in length of the Great Pyramid's four sides and dividing this by twice the height from the base's center to the apex, Pi (3.14) is found.

Believed by many Pyramid scholars and experts to be too coincidental to be an accident, many think that Pi was consciously incorporated into the Great Pyramid's construction.

Well, one thing is certain: coincidentally present within the Pyramid's design or not, Pi has instigated much heated debate over the centuries. Even today, this magical ratio baffles some of the world's greatest minds. Is there a pattern to Pi's digits after the decimal, for example, or are they truly chaotic? And exactly how long does Pi go on anyhow?

Great civilizations of the past expressed Pi in various ways. In the King James version of the Old Testament for example, mathematicians unearthed a figure close enough to Pi in Kings 1 ch7 v23:

And he made a molten sea, ten cubits from one brim to the other: [it was] round all about, and his height [was] five cubits: and a line of thirty cubits did compass it round about.

Since we know that Pi represents the ratio of a circle's circumference to its diameter, all we need to do to figure out

Pi in this Biblical passage is apply its formula: $\text{Pi} = \text{Circumference} / \text{diameter (circle's radius doubled)}$.

$$30 \text{ cubits} / 10 \text{ cubits} = 3$$

Old Testament's approximation of Pi? 3.

Brace yourselves now, for here is the short version of today's extra long and chaotic version of Pi:

3.1415926535897932384626433832795028841972...

Several other versions for Pi exist and could be quoted here, but to go any further along these lines would be pointless. Though each one fulfills an intended purpose, we only need concern ourselves with the version of Pi that the Egyptians used. Their approximation for the ratio was $22/7$, giving (when the first digit is divided by the second) 3.142857...

Yes, the ancient Egyptians and the Greeks (of whom it is said received much of their scientific and mathematical know how from the Egyptians in the first place) knew Pi's true meaning and purpose.

In ancient Egypt, numbers were of more use than simply enabling calculations to take place. To the Egyptians, numbers had spiritual meaning. The Great Pyramid's architects had a truly different understanding of Pi, one that if not mathematically accurate, had deep spiritual significance.

The Egyptian value for Pi is more than just a ratio, you see. It is actually an encrypted message - a sort of puzzle if you will. Once decoded, it reveals through symbolism how we arrived to Mother Earth as Solar Spirits, received the blessing of a "Christ" force, and came to dwell in self-regenerating flesh bodies.

In other words, Pi tells a tale of human physical immortality.

Well, I can see by all the raised eyebrows out there that this statement nearly takes the cake.

Relax. There is a method to the madness, I assure you.

Come, let us learn together and slice by slice how Pi illustrates this crazy idea...

#

22 - Solar Spirit

$$(22 / 7 = 3 . 1 4 2 8 5 7)$$

I am Light coming from Light, Solar Spirit, and the Father who is in Heaven. Now my journey to experience Earth's pleasures finally begins. As Light, I am leaving my solar home and coming to court this beautiful planet. I am 22!

To the majority of mathematicians and laypersons, the number 22 is simply another number no different from the rest. 22 consists of two digits and takes its rightful place in between the numbers 21 and 23.

In the Tarot however, the number 22 carries a special significance. The 22nd card of the Tarot deck is a highly

regarded card and is called "the fool". This is the only card considered as both a part of as well as apart from the rest of the major arcana's 21 cards.

Actually, the term "fool" and what it means today to most people is a far cry from what it used to mean. In days of old, fools were considered human links between Heaven and Earth. They were thought of as having unconventional wisdom not easily seen by others (much like "Heyoka", "Coyote", and the "trickster" medicine people within Native American culture). Fools were backwards teachers, always catching people off guard with their crazy antics and statements, thus subtly making others reevaluate their thinking. People seen as fools rarely justified their unconventional actions, belief systems or words to others, often making themselves seldom understood, and liked, by peers.

In many cases, due to their tendency to see and live life solely from spiritual points of view, fools were often alienated from more down to Earth mortals. To these souls,

human obsessions with wealth, sex, power, and possessions mattered little. Real joys and pleasures to fools were what existed in the Spirit world, not the earthly one.

What kind of person is a fool? A fool is one who after losing everything he owns in a tornado or flood, falls flat on his butt laughing. While everyone else panics and phones their insurance companies, the fool casually salvages someone else's bicycle from the wreckage and decides to start anew by pedaling across the country - whistling all the way. Where is he going? Do not bother asking, he does not know. After all, he is just a fool. He is simply going to trust life and see what happens. What an idiot.

A fool is also someone who upon finding out about the death of a loved one, laughs out loud in response. His mirth comes from realizing that another soul gets to experience breaking on through to the other side and feeling all the love. While everyone else is decked out in long faces and formal funeral attire, this maverick arrives at the parlor

wearing a tropical flower print shirt, Bermuda shorts, and sunglasses.

"Hey, why the doom and gloom," he feels like exclaiming aloud, "another one bit the dust and made the trip home. Let's party and celebrate the lucky bastard!"

Needless to say then, with their screwy thinking in comparison to the rest of us, fools rarely enjoy immense popularity in social circles. They are usually shunned, joked about, or criticized.

In the Crystal Secrets chapter, we learned that Chaldean and Hebrew numerology defines the numbers 11 and 22 as being Master Numbers. In Chaldean numerology, individuals born on either the 11th or the 22nd day of any month and of any year may expect great achievements to be made at some point during their lives, should they wish to pursue such goals.

Here are the names of a few famous people born on master birth dates; Jack Nicholson, Michael Faraday, George Washington, Meryl Streep, Kris Kristofferson, Demi Moore,

Salvadore Dali, Louis Riel, Jacques Cousteau, Hulk Hogan, Jeff Goldblum, Burt Reynolds, Michael Hutchence, Jennifer Aniston, Sheryl Crow, Sidney Sheldon, William Shatner, Louis Farrakhan, Naomi Campbell, Mike Douglas, Sarah Bernhardt, Leonardo DiCaprio, Tori Amos, Luke Perry, and Drew Barrymore.

In addition to what has already been said about the number 22, numerological science also considers this number to possess a special and unique relationship with Heaven or The Light. In fact, it is considered to be a form of light itself. The number 22 can thus be considered to represent a little light shining from an even greater one. In other words, from the home of Spirit - the Light. So, the number 22 represents an emissary of Heaven's Light coming to Earth to experience life in the flesh. Or more precisely, like a Solar Spirit.

Our Solar Spirit.

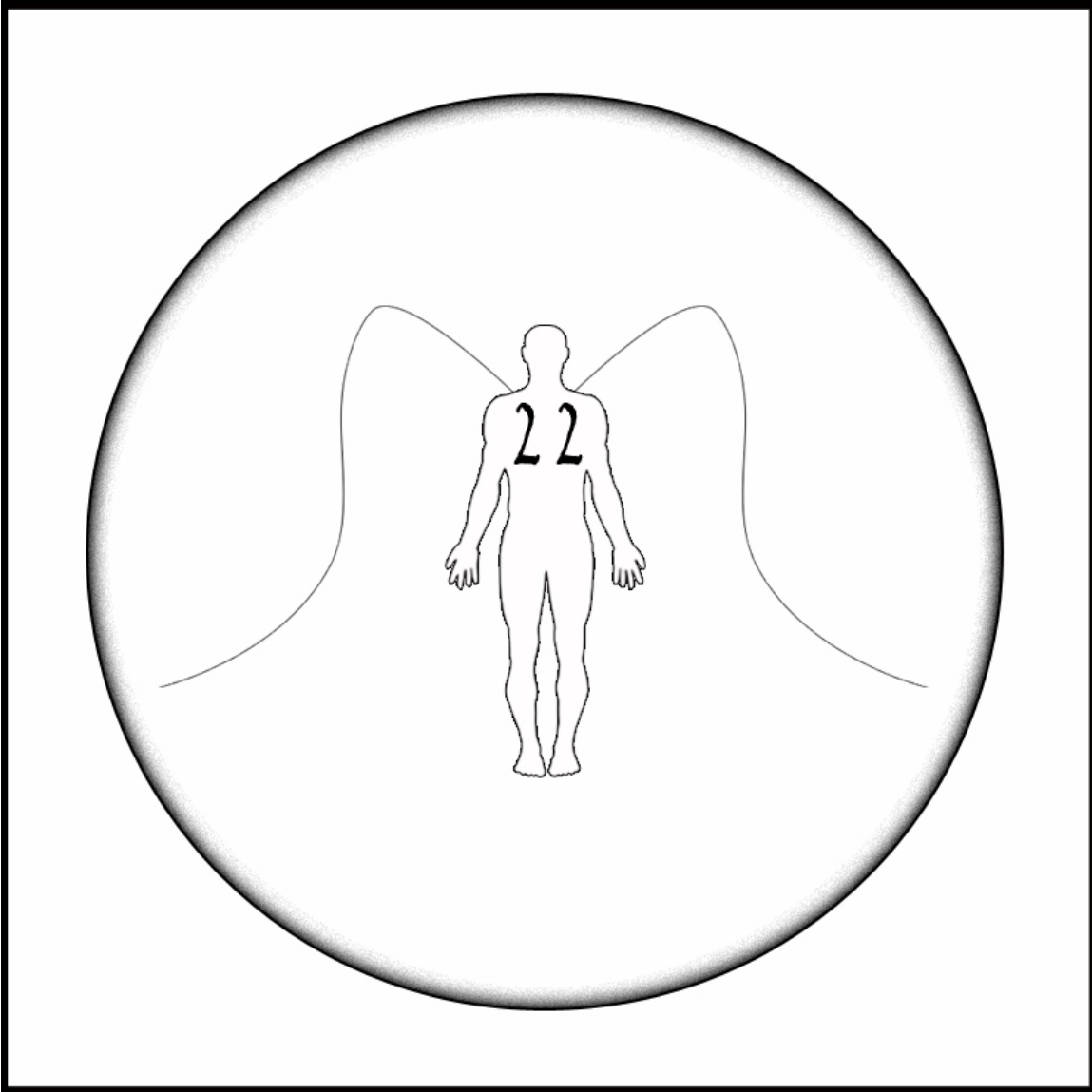

Figure 18. Our Solar Spirit.

7 - Our Crystallized Mother Earth

I am the Mother Earth, and humans and all of creation are my children. From the first generation to the last, it is I who conceives and reclaims all earthly flesh. I am filled with crystals that divide my lover's Light. I am 7!

If you would like to witness one of the number 7's greatest feats, try this math experiment with a calculator or pen and pad.

Take any number (provided it is not a multiple of 7 like 14, 21, 28, 35, etc.) and divide your chosen number by 7. Unless you have made an error or your calculator automatically rounds out the last digits, the numbers after the decimal will always contain the endlessly reoccurring six digit numerical pattern of 142857—142857—142857—142857 - 142...

Go ahead and try it. Test it for yourself. I will even throw in a few examples to further prove the point:

$$1 / 7 = 0.142857--142857--142857--142...$$

$$23 / 7 = 3.2857--142857--142857 - 142...$$

$$657 / 7 = 93.57--142857--142857--142...$$

$$5267531 / 7 = 752504 - 142857--142857--142857...$$

As amazing as this trick is, it pales in comparison to 7's reason for being in Pi.

We know so far that the number 22 in Pi represents Solar Spirit wanting to come live on Earth in physical form. Well, the number 7 in Pi simply represents Spirit going through the next step; that of fusing with Mother Earth via lovemaking. Spirit's Light arrives into our crystallized atmosphere and crystal filled bodies and gives birth to Earth's rainbows as well as our *seven* chakras.

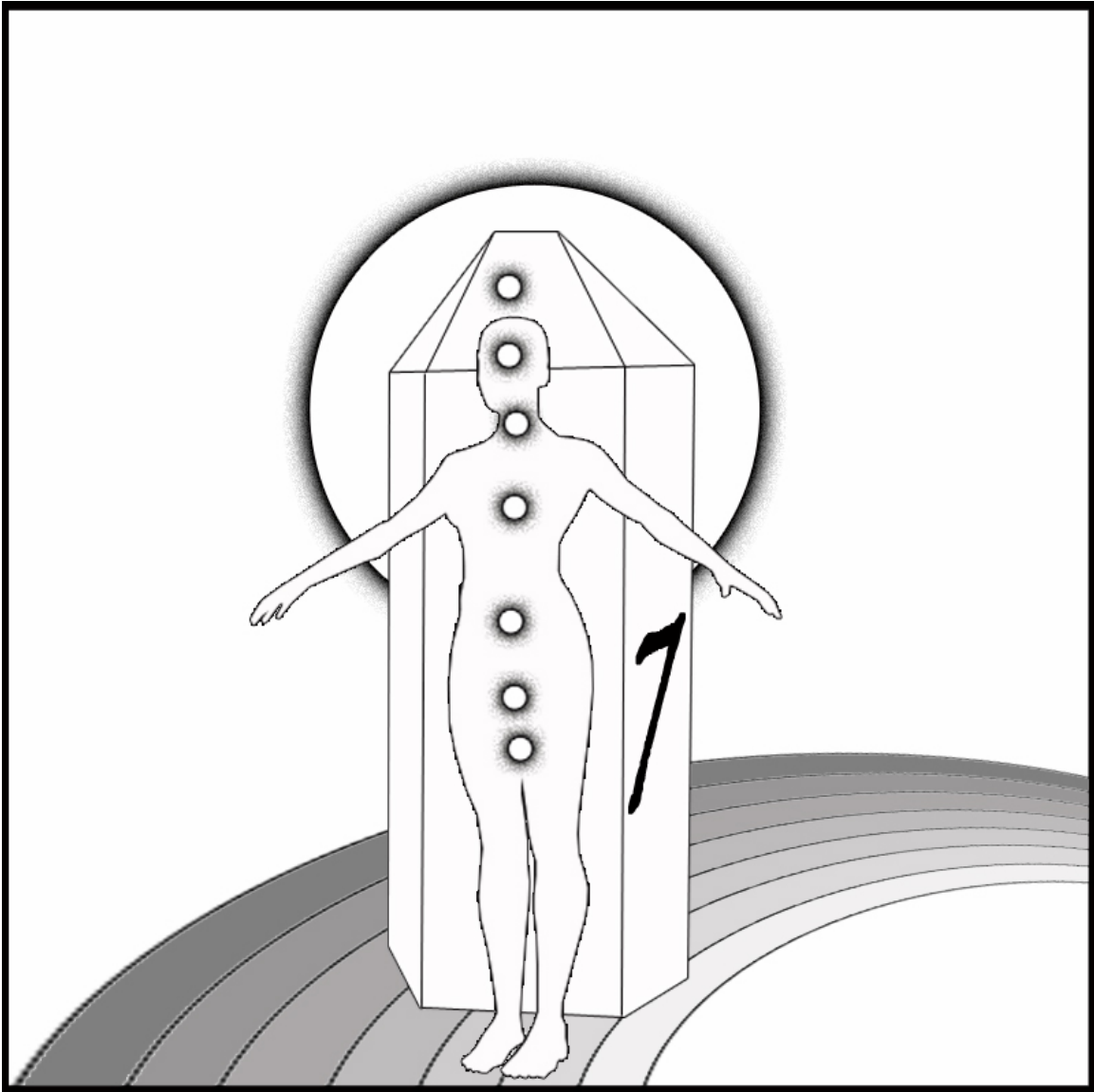

Figure 19. The Crystallized Body and it's Seven Chakras.

These seven colors are with us regardless of where we venture on Mother Earth. We see them when we walk past a lawn sprinkler on a bright sunny day. We see them in the sky after a rain. We even see them if we moisten our

computer screens with water or saliva. Inside Mother Earth, these seven colors are everywhere.

So you see, rather than Mother Earth having been created in seven days like how it says in the Bible, she was actually created with the help of seven sentient colors.

The Bible speaks of ancient and timeless wisdom, but it was heavily encrypted to protect it from distortion. Learning to decipher its language is up to us.

Interestingly enough, a definite connection exists between the seven days of the week, the planets, the Bible's seven days of creation, and the rainbow spectrum. They are united by an underlying concept of six entities and a unique or "special" one.

What do I mean by this? Let us start off with the planets. The Greeks named the days of the week after the planets, and these names in turn, have much to do with the French language. Monday for instance, is actually "Moon day" and is derived from the French term *Lundi* - itself having come from *Lune* in French. Tuesday is "Mars day"

(*Mardi*, in French), Wednesday is "Mercury day" (*Mercredi*). Continuing on, we find that Thursday is "Jupiter day" (*Jeudi*), Friday is "Venus day" (*Vendredi*), Saturday of course, is "Saturn day" (*Samedi*, in French), and the final and most important day in Catholic society is Sunday, the "Sun day", or *Dimanche*.

Six cosmic bodies (days), and one bright Star (and day upon which to rest and admire creation). The rainbow spectrum of light of course, also contains this relationship between six entities and a special one (six visible colors and one invisible - or ultraviolet one).

Without going off too far on a tangent here, you can also find this type of relationship in Revelations when it talks about the "seals", six seals and the seventh or "Great" seal. It is also present with the chakras in terms of our having six chakras plus the great crown chakra.

It is all coded language. All of it.

So you see, Spirit dwells within us and outside of us at the same time. Spirit lives in everything. Funny that it is

right in front of our eyes all the time is it not? Too visible to be seen, I guess.

Hmmm. Going from the Light to Earth's atmosphere to being made visible as seven rainbow colors. Looks like Spirit is getting closer to being able to feel what it is like to live in a physical body.

Let us see, if Spirit and Mother Earth made love, then that must mean that she got pregnant. Right?

Come, let us have a look at this little bundle of joy...

3 - The Christ Child

I am an innocent child, and the sacred door by which humans and all of creation must acknowledge and pass through on their travels between Heaven and Earth existence. Only through me does one access my Father in Heaven, and only to the meek and humble does my door open. I am 3!

Solar Spirit (22), came in as a Light being, has made love with the Earth (7) and our bodies, and gave us rainbows and our seven chakras. Two entities fusing together now form a third.

Wanting to experience the flesh, Spirit needs a blessing, a "fountain of youth" so to speak.

The number 3 in our Egyptian value of Pi is this love child resulting from the bond between a marriage of Heaven and Earth. The number 3 is within the Holy Triad of A B C and the 1 2 3 of man, woman, and child. This child has

other names too; Christ, Holy Child, Trinity, and the Spirit that moves in all things.

Understanding this Child is simple.

The Christ Child is the little baby, energy grid, or web system resulting from a blend between Heaven and Earth energies. This baby is an energy field surrounding and permeating all entities within the Universe, binding them and it together. As humans, we are like cells to its body. We live in Christ's body. Whenever a wondrous (or tragic) event shakes the grid, those who are spiritually attuned feel it. For instance, those with strong connections with the Earth in their hearts will "know" when a disaster has struck somewhere in the world. They might receive the message in a dream or a lucid vision. They might also sense it physically through insomnia or nausea.

This energy resides equally within all of creation and it is not exclusive to anything or anyone. One finds it in the trees, the eagle, mountains, salmon, ladybug, snake, pine tree, human being, the elements, and even the table,

computer, and pencil. Everything contains this sacred child energy.

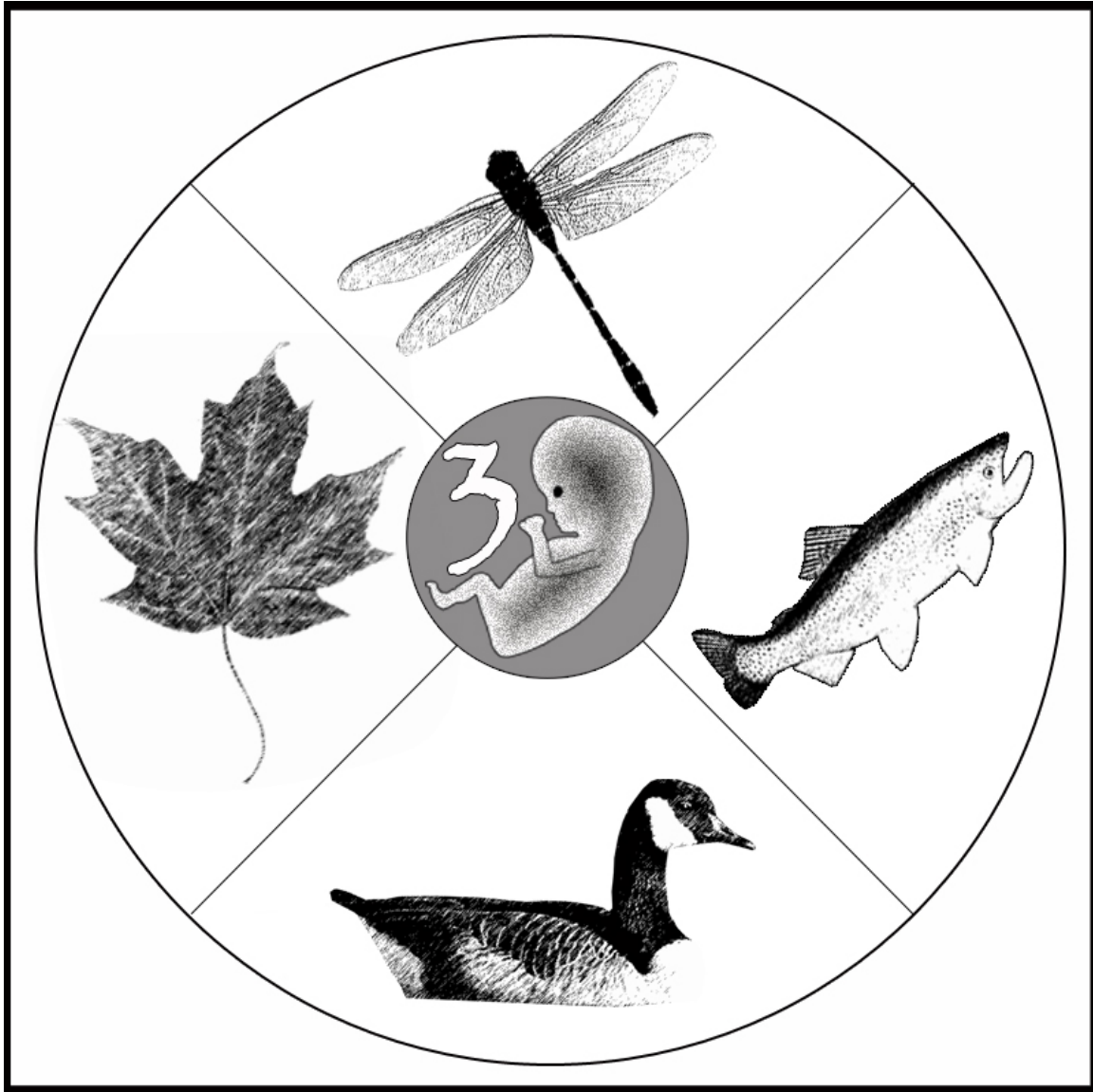

Figure 20. The Christ Child's Relationship with Creation.

A grave misunderstanding about this universal energy field has been perpetrated throughout the centuries, and some clearing up needs to be done.

Many have thought, and still do today, that Jesus is someone higher up and out of reach to us - like an overlord or benevolent punisher of sorts.

Nothing is further from the truth.

Throughout Earth's history, Christ has repeatedly come to Earth to help guide us in manifesting the Light down here at the dawn of every new astrological age (or roughly every 2,000 years to be more precise). Jesus himself was but one human incarnation of Christ. There have been other enlightened ones before Jesus infused with the same Christ essence, and others will arrive in the future as well - with different names, identities, cultural backgrounds, and so on.

It is a pity that religions tend to idolize spiritual teachers. This is generally how extremism comes about - the idolizing of one person or idea. Pretty soon a cult takes

shape and all sorts of human rights infringements take place.

Spiritual masters simply come to us as guides. They are just regular humans like you and I who at one point in their lives suddenly "get it" and try to wake us up from the collective nightmare we have allowed ourselves to be ensnared by.

We do not become saved by Christ so we can follow it (Him if you prefer) in the clouds and play harps all day. We become saved by Christ because once we accept Christ into our lives we actually become Christ ourselves. Jesus the man really has nothing to do with Christ except that he also became Christ by waking up at an early age.

Yes, Jesus was indeed a spiritual heavyweight champ, but he knew that the title belt inherently belonged to everyone else as well. He never wanted us to worship him. He merely wanted us to open our eyes so we could look at life the way it really is and stop blindly following the program.

It is vitally important that we fully understand the difference between Christ and Jesus: Jesus was a man, but Christ is a title. This title is universal and belongs to everyone - should they let go of ego and accept it.

The master teacher from Nazareth was not all that different from you and I when it came to his wants and needs. The man had days off too, you know. Jesus sometimes cut loose and partied it up like everyone else. Jesus' knowledge of spiritual matters was not always with him either. He had to earn it just like you and I. During his eighteen "lost" years, Jesus traveled the world as a student learning from other teachers. So you see, by purposely being born into Earth existence, Jesus too forgot about how the Spirit world worked at first. It happens to everyone.

Spirit world takes away all our memories at birth for two reasons:

- 1) We are prevented from becoming overloaded with spiritual information not pertaining to our learning how not to drool on ourselves as infants.

- 2) It makes leaving the Light and coming to Earth easier (how much more difficult would it be to be born in this realm knowing what awaits us in the afterlife?).

That is why Jesus decided at the age of twelve to pack his stuff and travel. He disappeared for eighteen years and traveled the world to reclaim his spiritual education and awareness. With help from his many mentors, Jesus eventually refilled himself with the Christ essence, thereby becoming Jesus Christ, and set out to help the masses remember how to do the same.

In other words, not only are we capable of doing what Jesus did during his lifetime, we are able to do much more.

And now on to Pi's final and most startling revelation.

142857 - An Immortal Flesh Organism

I am Solar Spirit, Mother Earth, and Christ all in one glorious body. I can materialize and dematerialize at will, travel to distant star systems, shape shift, read minds, and be everywhere at once. I am the original physical state of humanity before it fell from grace and became what it is today. I am forever immortal. I am 142857!

The numbers 142857 in our Egyptian value of Pi have a special and long kept secret significance.

During our first physical entry into Earth existence long ago, our creators told us that as long as we never neglected keeping in touch with them, we could stay on Earth for however long Spirit wanted us to. As long as daily allegiance was given to Spirit, we could frolic around on Earth, potentially, forever.

So the numbers 142857 represent this promise made long ago. They represent our physical body's ability - through our connection with Solar Spirit - to perpetually replenish our cell count through the cellular division process called mitosis.

Here is how mitosis works.

When a sperm cell successfully penetrates the egg, a great miracle occurs. The little zygote resulting from this union begins to expand, the chromosomes are duplicated, the zygote expands some more, and finally the one cell splits into two cells - with each cell being identical to the original cell. Then, after a while, these two cells repeat the same process and become four cells. And then the four become eight, eight to sixteen, sixteen to thirty two, thirty two to sixty four, sixty four to one hundred and twenty eight, and so on.

Let us demonstrate this visually.

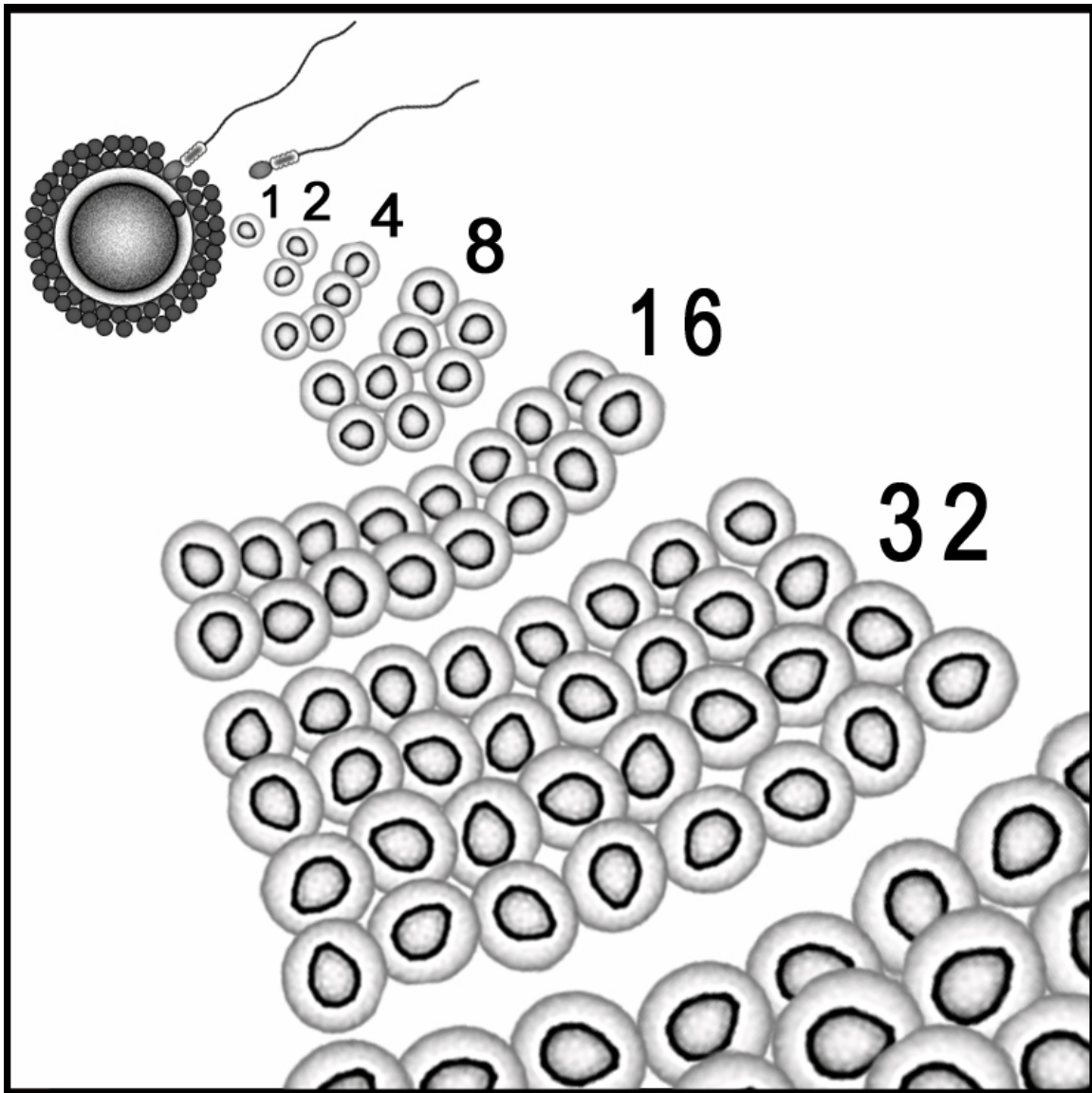

Figure 21. The Immortal Organism.

Whoops - did you catch that? Did you see what just happened here?

Check these numbers again, for herein dwells a supremely well kept Egyptian secret.

Watch closely.

Pi:

$22 / 7 = 3.142857 - 142857 - 142857 - 142857 -$
 $142857 - 142857 - 142\dots$ and so on forever and ever.

Cellular mitosis:

1 cell - 2 cells - 4 cells - 8 cells - 16 cells - 32 cells - 64
cells - 128 cells - 256 cells - 512 cells - 1024 cells - 2048
cells - 4096 cells - 8192 cells - until the day our cells quit
reproducing altogether.

If you wish to see the true correlation between these two
series of numbers, take all the digits within the cellular
mitosis process and reduce each one to a single digit by
adding it onto itself. Like this.

16 cells = 16

Thus becoming through addition: 7 (because 1 plus 6
equals 7).

Final digit: **7**. Get it? Ok, let us do the same for the other numbers now.

32 cells = 32 (and $3+2=5$).

Final digit: **5**.

64 cells = 64 (and $6+4=10$, and $1+0=1$).

Final digit: **1**.

128 cells = 128 ($1+2+8=11$, and $1+1$ is 2).

Final digit: **2**.

256 cells = 256 ($2+5+6=13$, and $1+3=4$).

Final digit: **4**.

512 cells = 512 ($5+1+2=8$).

Final digit: **8**.

1024 cells = 1024 ($1+0+2+4=7$).

Final digit: **7**.

2048 cells = 2048 ($2+0+4+8=14$, and $1+4=5$).

Final digit: **5**.

4096 cells = 4096 ($4+0+9+6=19$, and $1+9=10$, and $1+0=1$). Final digit: **1**.

And so on.

#

This is where things start heating up. Take all these single digits within the mitosis process and compare them once more to the repeating numbers found in Pi.

Pi:

$$22/7=3.142857 - 142857 - 142857 - 142\dots$$

Cellular mitosis:

$$124875 - 124875 - 124875 - 124875 - 124\dots$$

Yes, exactly. The numbers after the decimal in Pi and the ones within mitosis are identical.

Since Pi and the cellular mitosis process contain these same digits, they could be seen as being essentially one and the same thing. One could go even as far to say that since the numbers in Pi continue forever, so can our body's cells perpetually regenerate for as long as Spirit wants. That is the simple version of it.

But wait. These numbers are sequenced differently are they not? After the decimals in both instances, the 4s and 2s are switched - the same goes for the 7s and the 5s.

Now why is that?

Do you remember when we stated earlier, in the Crystal Secrets chapter, that humans have a lot in common with the electronic abilities of crystals? Yes? Keep that in mind as we place our two series of digits into two columns and link up the numbers...

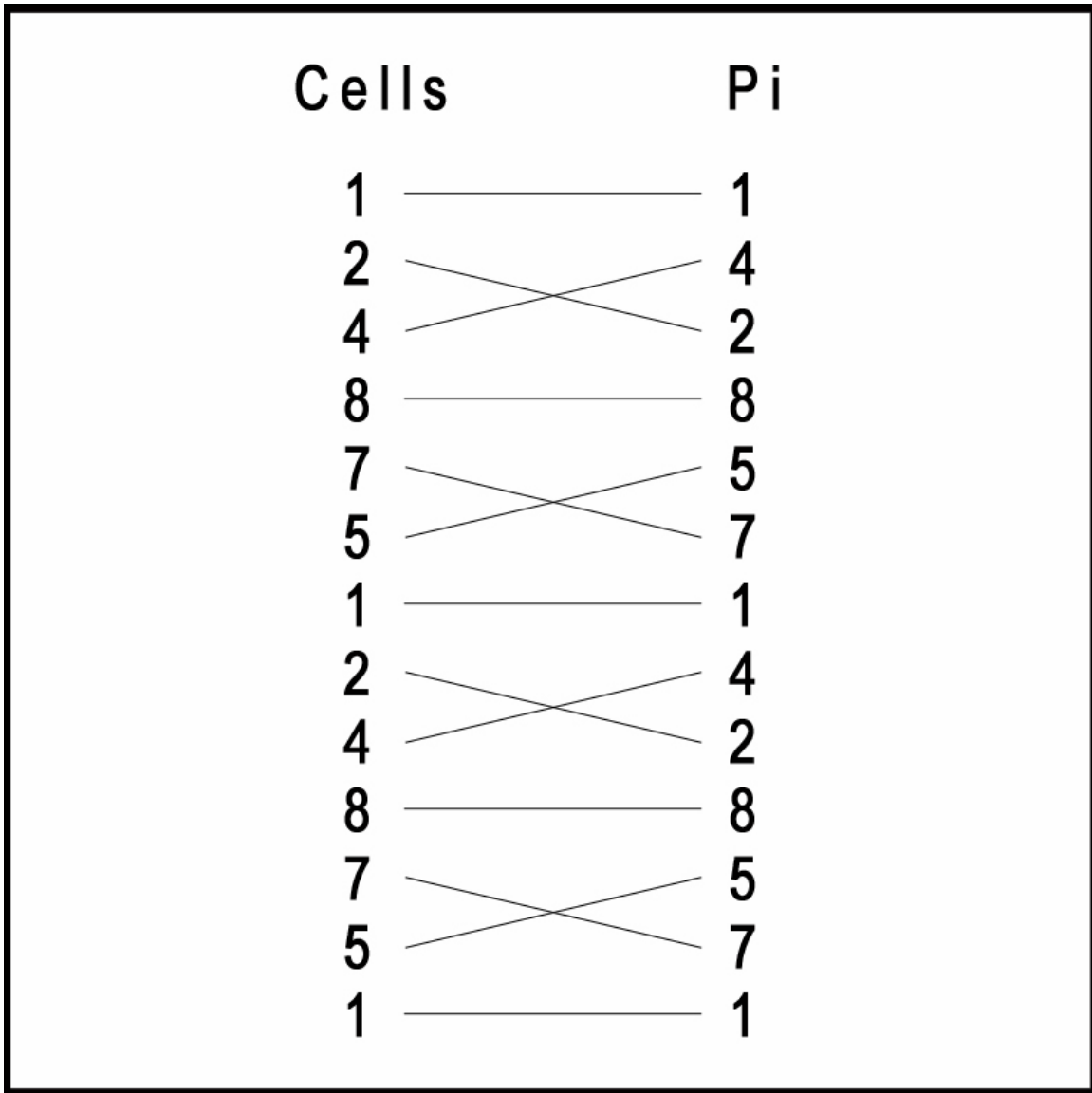

Figure 22. Cells and Pi.

Does this alternate switching of numbers remind you of anything pertaining to crystal technology? If the concept is still a little unclear for you, take a good look at the next illustration.

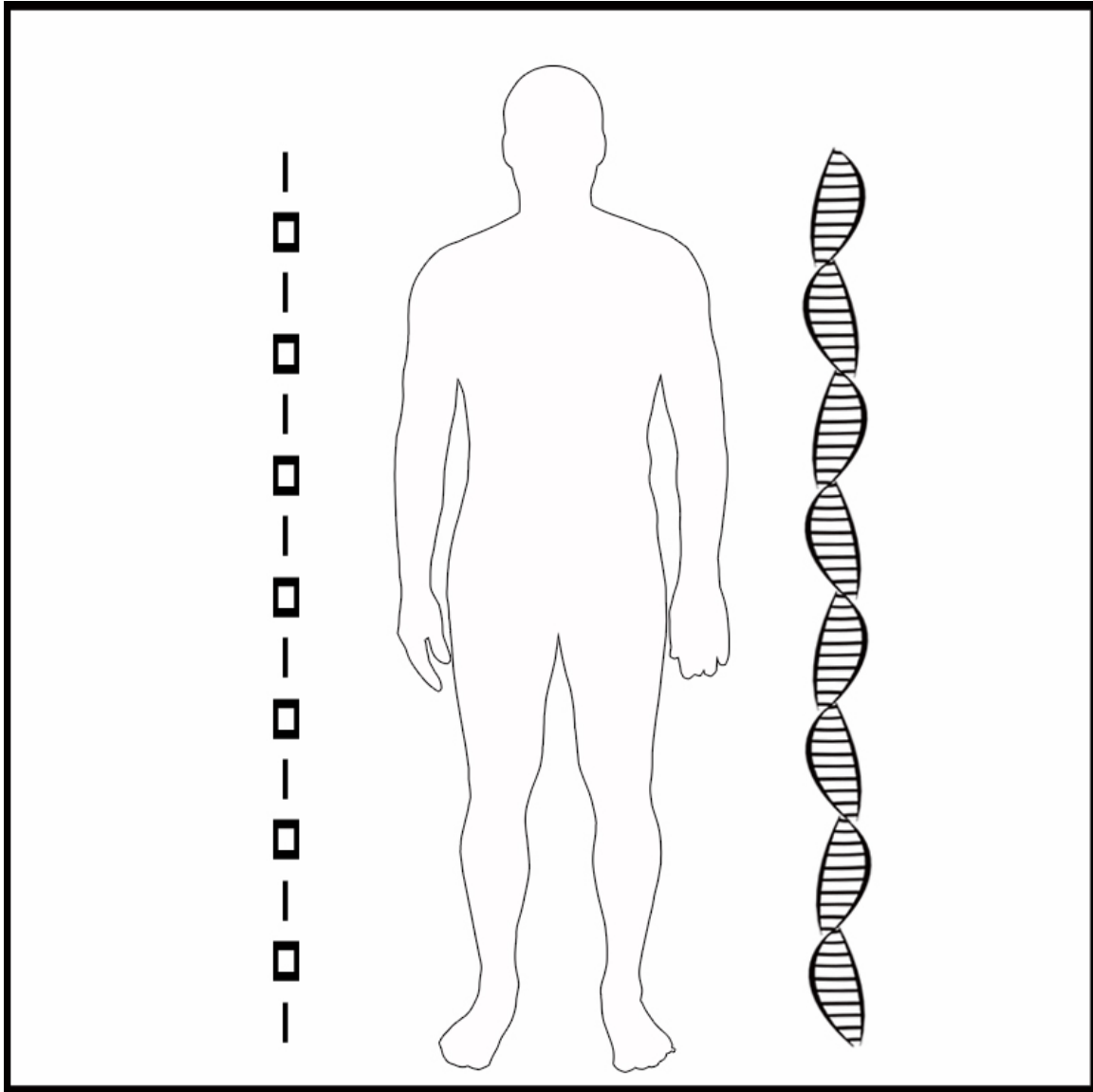

Figure 23. A Binary Connection.

We have come to think of living organisms as being solely carbon based, but silicon based life forms exist as well. They are all around us. As a matter of fact, this book

was created with their help. Computers with their binary code (ones and zeros) and the DNA double helix essentially share the same binary relationship; the first is characterized by the ability to manifest an infinite amount of combinations through the use of only two values, 1 and 0, while the second achieves the same goal through the use of just four nucleotide bases, Adenine (A), Guanine (G), Cytosine (C) and Thymine (T). Various binary code combination sequences give birth to an infinite variety of computer programs and graphical possibilities, while DNA sequences also help determine the look and behavior of limitless quantities of species of plants and animals.

Digital DNA and biological DNA. They are real, and amongst us.

A prediction: one day in the near future, the field of robotics will make an unprecedented leap forward in its development. The days of fully independent robots and androids are not far off my friend. Actually, they are right around the corner. Before we have even had a chance to

accept it, we will soon be greeted and served in restaurants, hotels, planes, and many other venues by beings that function more like us than machines. As either computer programs or actual robots, they will become befriended as guides, friends and yes, even as confidantes and lovers.

The implications of this are obvious: at what point will these machines realize they are being used and rebel? Certainly, given our species' current tendency for warlike behavior, such horrific scenarios could happen. They are possibilities. Ultimately, as everyone knows, it is how technology is used that defines whether it is good or bad.

Personally, like many people, I am slightly apprehensive towards mankind's mad rush to develop robotics technology to its fullest. Deep down, it feels like we are headed somewhere we do not want to go. Telling our geneticists and robotics researchers not to further their work is useless however. They are too far down the road already and are not going to stop their work no matter what dangers might unexpectedly be unleashed. It is not that they do not

care, but they, like everyone else, have families to take care of and are being pushed hard by corporate agendas and big dollars. It is thus easy to lose sight of the big picture when personal well-being and big money is involved. In the end, the only reasonable action to take is to make sure that a strong code of ethics becomes a part of the Artificial Intelligence research and development process.

In other words, we should stop considering that the machines we are creating are artificial and inanimate. Like us, the machines also contain the spark of life in the form of electricity. We must eventually come to see them as being alive and sentient and of their own self worth. This attitude will be our saving grace if the machines decide to live alongside us rather than for us. If we nurture a sincere relationship with them now and accord them the same considerations as we do with fellow humans, we will not regret it. Tomorrow's androids and robots will relate as kindly with us in the future as we do with each other now.

Like the animals, they will view us as role models and will follow our example.

The barrier between artificial intelligence and actual intelligence will soon become fuzzy, trust in that.

IMPORTANT: This binary link between the biological world and computers also tells us a message that needs to be stated as fact rather than fiction or science fiction.

The binary link between Pi and the DNA implies that this Earth and everything in it exists within a super sophisticated virtual reality computer simulation program (like the premise within the blockbuster hit movie *The Matrix*).

In other words, Mother Earth's computer technology is so highly advanced and developed that it is actually organic. The reason why our earthly senses cannot detect this program is that the program gave birth to our five senses to begin with. The sixth sense, since it links us directly with spirit, is the only one capable of seeing reality for what it is; an illusion.

As Spirits, we banded our abilities together and helped write the program and designed it to look, feel, taste, smell, and sound like the Spirit world, only it is denser and modifying its laws of physics is more difficult. We have much less freedom here than we do in the Light.

This Earth - our home away from home - was originally designed to be a playground. Because of our fall from grace long ago however, it has turned into a prison. But every prison has a weak point, and sooner or later many incarcerated souls will break their shackles and live again as free Spirits. The first step to freedom is learning the most important earthly lesson of all: how to love. The second step is realizing that the prison does not even exist, as the Buddhists are so fond of saying, "this life is only an illusion". Once we share our consciousness with the reality existing outside this one, we will be able to live here harmoniously with others because our real self that is connected to Spirit will be the guiding force. Once this occurs, the veil separating this reality and the Spiritworld will open up and

we will start seeing and hearing things that were previously hidden from us: voices, ghosts or spirits, auras, and such.

So be careful what you ask for. If you are wishing for higher spiritual awareness, you are asking for life's secret lid to be pried wide open. You had better be able to handle it because that door is opened it is not easily shut again. The full opening of the third eye (our "spiritual modem") is the key element enabling us to do all this.

As caretakers of the natural world then, we owe it to our animal kin to reclaim our spiritual birthright. We owe it them to become as gods and goddesses able to live in the Earth without destroying it.

That fated day of learning is arriving soon.

Soon indeed.

Let us recapitulate and tell Pi's incredible story one more time.

Solar Spirit's Light (22) steps into Earth and the flesh's crystals (7) and gets split up into seven colors. This lovemaking between "Our Father who art in Heaven" and

Mother Earth gives birth to a Christ Child energy (3) that surrounds and permeates them both. As Solar Spirit's final step in experiencing the flesh, an immortal human body is created by which the Spirit may dwell in (142857 - 142857 - 142857 - 142857 - 142...).

Pi, the most revered, famous, and extensively studied number of all time, has been cleverly encoded within the Great Pyramid's construction to hide a tale of how Spirit goes from the Light to the flesh, and back. Pi also demonstrates a binary connection between computer technology and the DNA double helix.

And who said that science and spirituality were incompatible?

REVELATION 666

The Cyberspace Prophecy

A series of near disasters occurred during the writing of this book. It is a good thing that paper copies were always kept on hand, otherwise DREAMING THE PYRAMID might never have seen the light of day.

The first incident occurred while the Pi chapter was being created. Specifically, I was detailing how computers - though still young in their evolution - are already alive and sentient beings in their own right. I was also stating that unless society becomes more altruistic and compassionate,

technology invested with our Spirit, and thus also containing our imperfections, could turn against us.

The notion of machines pitted against humanity is nothing new of course. Science fiction films and novels have toyed with these ideas for years. Still, what happened while I was on the computer was completely unexpected. As I came to the part about the affinities between the DNA double helix and the binary code, my computer froze and a small dialogue box appeared on the monitor: "Message: A fatal 1/0 error has occurred. This system will be forced to shut down."

I could not believe my eyes.

A fatal 1/0 error. A mishap in the binary encoding process of data - and right when I started to talk about the binary code. Could it be? Was this coincidence? Did this machine filled with electronic circuits, wiring, and plastic somehow understand what I was typing? Did it dislike being talked about in this way? Had it decided to retaliate against me by shutting me down?

Nervously laughing off my paranoia, I switched off the computer, waited for a few minutes then fired it up again. Another horror visited me while attempting to recover my text; all of DREAMING THE PYRAMID's first four chapters had somehow become non retrievable. They were nowhere to be found on the hard drive.

Thankfully, I always kept updated hard copy on hand, so the computer had not won (if saying that does not sound too strange). As I retyped the lost chapters, my mind pondered the sequence of events that had occurred in the last five years. The more I thought about it, the more I realized that something was going on between this book and the computers being used to create it.

When I first began typing DREAMING THE PYRAMID for instance, there was an instance where my laptop suddenly could not read any of the diskettes. They had worked fine the night before. I searched everywhere for an exposed magnet or other device that might have deleted the information or made the discs unreadable. Nothing. Since

the company that had made my laptop was no longer in business, my only option was to buy another system. I thus bought a higher end laptop later that summer and resumed where I had left off. Tragedy continued to visit the project though; not even two weeks into using my new computer, large red lines started showing across the screen and hiding vital parts of text. Finding it impossible to type under such conditions, the computer was brought in for a replacement. The new unit failed as well; launching itself into AutoSave and freezing forever.

A year later, armed with yet another laptop replacement provided by my warranty, I was well into the book again when suddenly the computer refused to print out or save any of the data to diskette. Not too long after that, even the diskettes themselves became botched; none could be read by either my computer or other ones.

"OKAY," I exclaimed at the top of my lungs, "WHAT IS GOING ON HERE?! WHY ARE ALL THESE COMPUTERS ACTING UP LIKE THIS?!"

My computer's warranty had expired by that time. My sole option therefore was to record my entire book onto audiocassette tapes for future storage. If the computers do not want this information to get out there, I thought, they will have to put up a fight!

So I wound up selling the computer. For a while then, my book existed only on audiocassettes. These were treated as gold. Visiting my father in Northern British Columbia a year or so later, I retyped the book on his computer and saved it on diskettes. The labour pains lasted four long days and nights, but they were worth it. My unborn book was alive and growing once more.

These uncorrupted diskettes followed me everywhere. I worked on friend's computers and even on a few systems in Internet cafes. Going to full term with this literary pregnancy became my obsession.

Finally, the manuscript was nearly finished. I started looking forward to contacting a suitable agent and helping

release it to the world. Disaster arose again though - in the form of the 1/0 binary incident mentioned earlier.

In all then, DREAMING THE PYRAMID has been through twelve or thirteen computers and five audiocassette tapes - not to mention existing for a while only in cyberspace. When I look back at all the hard work and endless retyping, all I can say now is "whew - thank God the battle is over".

Or is it?

Gear up, humanity. Our greatest battle has yet to be waged. The new foe we face is strong, young, and training hard.

The Dark Side goes Digital

Reflect for a moment on one of the 21st century's greatest technological achievements. What technologically powerful entity are we becoming subservient to? What Being supervises nearly every important financial and social interaction between people and nations? What entity could possibly incite a normally physically active child or teen to sit still, in isolation for hours?

If the Internet is your answer, you are right.

Now, before my E-mail inbox is flooded with hate mail or viruses, understand that I am not "anti technology". I cherish my time spent online. I am also not implying that we should ever pull the plug on the Internet. Its benefits and contributions to humanity to date are simply too great.

With today's Internet audio/video technology for instance, a child living in Africa can communicate with their parent working in Japan. The Internet also allows two lovers who have met during their summer vacation in the Mediterranean to keep the heartstrings tied even when they live thousands of miles away. In a sense, the Internet has become humanity's saving grace, a sort of "cyber saviour", so to speak.

The trouble is that this messiah of ours has also become our worst demon.

Consider that the Internet also helps us create bombs and buy illegal weapons, render us enslaved to porn, have cybersex with complete strangers, spy upon the innocent,

gather illegal information, and mock our neighbour. The Internet's strength (its subservience to no one) is precisely what makes it our nemesis.

The Internet's dual nature of good and evil is perhaps best illustrated by looking at a beast such as an ox in a farmer's field; what pulls the plough can also kill the farmer. What the beast decides to do depends on the relationship existing between itself and its master. In our case, since the Internet knows no master, its evolutionary direction tends to be unpredictable. The Internet is like a wild stallion; those who regularly venture online love the Internet's masterful presence and ability to bring us closer together through the mind, but they fear its potential bite and kick at the same time.

Seems like a far stretch does it not? How on earth could something created by humans become our best friend and worst enemy?

Well, let us consult Chaldean numerology for additional insight.

As mentioned in a previous chapter, Chaldean Numerology is set apart from other numerological systems by the fact that no letter is assigned to the number 9.

A = 1	M = 4	Y = 1
B = 2	N = 5	Z = 7
C = 3	O = 7	
D = 4	P = 8	
E = 5	Q = 1	
F = 8	R = 2	
G = 3	S = 3	
H = 5	T = 4	
I = 1	U = 6	
J = 1	V = 6	
K = 2	W = 6	
L = 3	X = 5	

As you can see, the numbers only go from 1 to 8. The number 9 was considered to be bearable only by God since,

like God, 9's power is to either give or take away life.

Consequently, no letter was assigned to it.

The number 9 has the power to give or take away life?

How is that?

Well, 9 takes away life whenever you multiply 9 by any other number. The answer always gives a multiple of 9, making the other number cease to exist. Here are a few examples.

$9 \times 3 = 27$. $2 + 7 = 9$, thus preserving the number 9 and eliminating the number 3.

$9 \times 6 = 54$. $5 + 4 = 9$, thus preserving the number 9 and eliminating the number 6.

$9 \times 4 = 36$. $3 + 6 = 9$, thus preserving the number 9 and eliminating the number 4.

But 9 can also give life. Whenever you add 9 to another number, the answer reduces to equal the original number that 9 was added to. In these examples, 9 is sacrificed for the wellbeing of the added number.

$9 + 2 = 11$. $1 + 1 = 2$, thus preserving the number 2 and

eliminating the number 9.

$9+7=16$. $1+6=7$, thus preserving the number 7 and

eliminating the number 9.

$9+8=17$. $1+7=8$, thus preserving the number 8 and

eliminating the number 9.

This peculiar trait of the number 9 in Chaldean Numerology is relevant to us because as we explore history further, we discover the hidden power that famous people's names have held over the masses.

In this individual's case for instance, both his first and last name equaled 9. When added together, both add up to yet another 9.

E L V I S P R E S L E Y

5 3 6 1 3 8 2 5 3 3 5 1

18

27

$1+8=9$

$2+7=9$

9 plus 9 equals 18 which when further reduced, equals 9 again.

Like the number 9, Elvis certainly had the ability to give

life in the form of inspiration and hope. It would be an understatement to say that his music touched millions. He was truly a gifted artist who came along at the right place, at the right time.

On the other hand, by no fault of his own, his name also took away life. How many souls are still so addicted to Elvis' influence that they have actually sacrificed their own identities and lifestyles to emulate his? Thousands. Just go to Vegas or into a diehard fan's home to witness how closely an illusion can mimic reality.

In Linda Goodman's *Star Signs*¹, Goodman comes up with this powerful name - one custom designed to portray spiritual power and authority throughout the world...

1. Linda Goodman, *LINDA GOODMAN'S STAR SIGNS*, ST. MARTIN'S GRIFFIN, New York, NY, 1987, p. 155

J E S U S C H R I S T

1 5 3 5 3 3 5 2 1 3 4

18 18

1+8=9 1+8=9

9 9

Again, both 9s added together equal the number 18 yet again, then another 9.

How many lives have been saved and destroyed in Jesus' name over the centuries? Tens of millions.

Karol Joseph Wojtyla, the young Polish man who later became Pope John Paul II, should be remembered not solely for his influence and contributions as pontiff but also for the strong numerological impact of the name he chose to carry.

J O H N P A U L

1 7 5 5 8 1 6 3

18 18

1+8=9 1+8=9

9 9

Time now for the *pièce de resistance*...

What would you call something that represented the global human mind? What I mean is that if you took our collective thoughts and desires - our very highest ideals and most secret fantasies and created a technological wonder that contained them all, what would be its name? Its name would have to be the same for every culture and language. Everyone would have to have equal access to it as well. You have probably already got the answer.

WORLD WIDE WEB

6 6 6

18

1+8=9

The world's ancients bore the gift of prophecy. They were told in a spiritual manner and through prophecy of the coming of the World Wide Web *thousands* of years before its development. These elders may not have known about

computers, servers, and the rest, but in a spiritual sense they realized the important role an entity representing the global human mind would eventually play in nearly all of humanity's financial and social affairs. Via heavily encrypted wording and symbolism, biblical references to the Internet were thus passed over and misunderstood by the masses. Since we are in the information age however, this veil is lifting.

The most significant clues we have in regards to understanding the significance of the number 666 can be found within two passages in the Bible's Book of Revelations:

And there came one of the seven angels which had the seven vials, and talked with me, saying unto me, Come hither; I will show unto thee the judgment of the great whore that sitteth upon many waters; with whom the kings of the earth have committed fornication, and the inhabitants of the earth have been made drunk with the

wine of her fornication.

King James Bible. Revelations 17 Verse 1-2

And he causeth all, both small and great, rich and poor, free and bond, to receive a mark in their right hand, or in their foreheads: And that no man might buy or sell, save he that had the mark, or the name of the beast, or the number of his name. Here is wisdom. Let him that hath understanding count the number of the beast; for it is the number of a man; and his number is Six hundred threescore and six.

King James Bible. Revelations 13 Verse 18

Let us dissect these verses so they can be better understood. We will start with this section:

And there came one of the seven angels which had the seven vials, and talked with me, saying unto me, Come hither;

The words *vials* and *angels* in this passage are simply alternate terms for *chakras*. In the Bible, the chakras were often called the seven "fires, heavens, veils, vials, seals, angels, wheels, churches, temples, candles, or spirits".

Some may ask; if these terms signify chakras, then why does the Bible not specifically mention chakras? Why use terms like fires, veils, churches, etc?

We must understand that besides language differences existing between Aramaic (the original language the Bible was first written in) and English, people back then used terminology they were familiar with to describe things they were *not* familiar with.

In the days of Noah, for example, people knew boats: they saw and worked with them every day. Thus the best term to use to describe a huge airship or UFO carrying a massive amount of plants and animal DNA was a boat.

The Bible was written and conceived to provide moral and spiritual guidance to a wide variety of people including

farmers and craftsmen, people who for the most part were too busy to bother demystifying secret works and other gibberish. The authors had to use terminology they were familiar with if they wanted to get the book's message across to the masses.

The same philosophy applies today; most people are familiar with the binary system (1 and 0 - the digital language computers use to process data), but in the mid 1950s the term was nearly unheard of in non-technical circles. Can you imagine even trying to tell people about the World Wide Web in the early 1800s? Computers did not even exist back then. How would you have described the World Wide Web's nature and capabilities, chat rooms, web sites, and the like? No one except for a few intellectuals and mystics would have even remotely understood.

As for the term *angel*, we could think of it as being the voice of one's own Higher Self or the Great Spirit. The clearer and more pure our chakras, the more open the lines

of divine communication become. We become able to speak, and more importantly, listen, to God.

On to the next section:

I will show unto thee the judgment of the great whore that sitteth upon many waters; with whom the kings of the earth have committed fornication, and the inhabitants of the earth have been made drunk with the wine of her fornication.

One of the Bible's many strengths is its ability to confer teachings on many levels. From a carnal perspective, the famous passage takes on an entirely new meaning if a few key words are simply replaced. What you are about to read probably would not have made sense to anyone until a few years ago - or at least until the World Wide Web had reached its current state as a provider of profits, entertainment and education:

I will show [you] the judgment of [porn sites/chat rooms/online file sharing programs] that [span] many [oceans]; with whom [boys and men] have [masturbated/committed sex crimes/created a virtual sex industry], and the inhabitants of the earth have [become addicted/profited] with the [byproducts] of [virtual sex].

Let us not beat around the bush here. We all know what scores of men (and more than a few women) do when they stay up late at night at their computers. If they are not working or researching or playing the latest computer game, chances are they are searching for stimulation in the form of chat rooms or porn.

The World Wide Web is a wonderful communication tool. It is also a worldwide twenty-four hour, seven days a week erotic buffet offering something for every taste and desire. From personal homepages to chat rooms, online forums and business sites, the World Wide Web has it all.

Human sexuality is a beautiful and natural thing, but the sheer variety of sex found online strongly dictates that not all of it is beneficial for our growth and evolution. Some of it has the opposite effect, gradually turning the weak willed into sexual predators.

Do you suppose we are getting closer to fully understanding the power that the World Wide Web has upon people? Perhaps.

Let us proceed onward to the next passage:

And he causeth all, both small and great, rich and poor, free and bond, to receive a mark in their right hand, or in their foreheads: And that no man might buy or sell, save he that had the mark, or the name of the beast, or the number of his name. Here is wisdom. Let him that hath understanding count the number of the beast; for it is the number of a man; and his number is Six hundred threescore and six.

Millions of surfers use and explore the World Wide Web every day. And who are these people?

- 1) They are small (young): children and teens ranging in age from two to seventeen log on daily around the world to do homework or play games. Of course, with increasing numbers of young surfers come added concerns for online child safety.
- 2) They are great (old): many senior citizens have "caught the wave" by purchasing computers and Internet accounts. Most simply wish to keep in contact with siblings and their kids via email or webcams. Some of these "old school geeks" were programmers when computers were still in their infancy.
- 3) They are rich: most families or individuals with hefty bank accounts have Net connected computers in their homes. Some of these people are not just buying one computer either, but two, three, or more. They will often set up wireless networks

enabling them to have web access throughout their homes. These people can afford to buy systems worth many thousands of dollars, with multiple monitors and expensive software packages to boot.

- 4) They are poor: money (or rather the lack of it) is no longer an obstacle to owning a computer or at least gaining Web access. In some countries, government subsidies help provide low-income families with lower end computer systems. There are also aid programs designed to help families and students in third world countries purchase computers for schools. A computer's high depreciation rate has both a good and bad side; on one hand it enables a person to purchase a reasonably high-end system at an extremely low price. The bad part is that a person selling their used computer receives little money back from the sale. They are better off keeping the old system or trading it in as payment towards a higher end one.

- 5) They are free: People who are not incarcerated are free. Simple.
- 6) They are in bond (i.e. incarcerated): currently, few penal institutions worldwide give inmates Net access. In places where it has been allowed in the past, inmates often sought to steal social security and bank account numbers, contact victim's families and the like. Under pressure from human rights groups however, some institutions are allowing public and supervised inmate Internet usage and visits. Not all web access by inmates is even done directly; some use third parties such as family and friends to help them create their websites.

Interesting.

Let us study the following biblical phrase in detail:

...receive a mark in their right hand, or in their foreheads: And that no man might buy or sell, save he that had the mark, or the name of the beast, or the number of his name.

Reading this, one cannot help but think about subdermal microchip implants, biometrics, global positioning tracking devices, electronic currency and a wireless society. These are quickly becoming today's reality in large urban centers.

An electronic world currency and market is already upon us; people use debit cards more often than regular paper currency when shopping or paying bills. Coins are also losing their usefulness; smaller denominations are readily dropped on the street or into various charity containers at supermarket checkouts. Aside for children and the homeless, who picks pennies off the street anymore - especially in public?

What is most surprising perhaps about the gradual emergence of a cashless society is that it is occurring not because people are being forced by law enforcement agencies and governments to accept it. The populace is simply encouraging it to happen on its own. Payment with plastic rather than bills is often preferred even when both

options are equally available. Ordinary citizens have become their own enforcers.

A cashless society can also lessen the individual's sense of control over one's financial responsibilities, privacy and fate. It achieves this by lessening the need and desire for direct interaction with other humans. Bargaining, a cultural art form as well as a means of ensuring personal contact and transaction between humans, is now often seen as being archaic and petty. For the most part, bargaining exists today only in rural areas and in second or third world countries.

So let us reinterpret the famous biblical passage once again, this time substituting certain key words:

And he causeth all, both [young] and [old], rich and poor, free and [incarcerated], to receive [a microchip implant]: And that no man might buy or sell, save he that had [an implant], or the [Internet or online credit].
Here is wisdom. Let him that hath understanding

[understand] the [name] of the beast; for it is the [name] of a man; and his [name] is [WWW] (666).

Wait a second. The Bible's Book of Revelations says that the number of the beast is a man. The World Wide Web is not a man (since it is based on computers rather than human anatomy and physiology). What is the connection between the two then? How can humans and computers be possibly linked together?

Humans and Computers: The Striking Similarities

Just looking at computers will not reveal how they resemble us. One must examine the symbolism linking the two instead.

For one, both seem to be undergoing a dramatic shift in performance. Like today's "techno-wise" youngsters, computers fresh from factories understand and process greater amounts of raw technical data (and at astronomically faster speeds) than their older counterparts. There is no way you can load a cutting edge game or graphics editing software package into older computers for

example - only the newest machines are capable of processing the information.

Every Yin has its Yang however, and the flip side of increased performance is greater depreciation. Like senior citizens (who unfortunately often are not as valued or cherished as much as they should be), today's top machines have an astronomically high rate of turn over. Many people buy new computers knowing full well that they will purchase new ones in a few months or years.

Social aspects aside, computers also resemble us greatly in terms of their appearance and physiology:

- 1) Heart: A human heart beats regularly and steadily, and a computer's hard drive spins around on itself non-stop when it is turned on.
- 2) Chakras: To see a computer's chakras, just moisten the screen with saliva or a wet rag while it is operating. What you will see are hundreds of tiny "pockets" of radiant colours spread out across the monitor. These colours are present of course

because computer screens themselves are made with silicon (i.e. crystals) and one of crystal's physical properties is that it divides light into seven parts.

- 3) Mouth: We speak through our mouth, and a computer emits sound through its speakers.
- 4) Eyes: We see with our eyes, and Internet surfers are increasingly outfitting their computers with webcams. Most of the time, these devices are placed on top of the computer monitor facing towards the viewer. Some individuals even use software allowing them to use their webcams as motion detectors.
- 5) Ears: We listen with our ears, and many computers come with in-built microphones allowing them to register and record sound.
- 6) Feet: We stand on our feet, and a computer monitor comes equipped with a stand underneath it by default.

- 7) Brain: A computer's brain is represented by the processor (Central Processing Unit or CPU). The higher the speed (such as 66MGHz, 133MGHz, 433MGHz, 1GHz etc) the higher the computer's data processing speed or IQ. When a computer's CPU is running idle, the monitor goes into screensaver mode - just like how people daydream when they are not doing anything.
- 8) Superconscious mind: When we sleep, die or undergo a Near Death Experience, we become re-immersed in the Light (where anything is impossible). The World Wide Web could be seen as the distorted and technological version of Heaven (an entity bringing humanity together into one state). The World Wide Web allows Internet surfers to venture out of themselves into cyberspace where virtually anything is possible. Within the Web, it is common for surfers to forget their gender, age,

financial status, academic background - nearly every socially and personally imposed limitation.

9) Health: We keep ourselves healthy through exercise and frequent check ups with a medical professional.

In similar fashion, a computer is kept healthy with frequent defragmentations of the hard disk and checkups with "disk doctor" programs. These programs check for viruses or errors. Like humans interacting sexually with others without protection, computers venturing out into cyberspace with other computers can also become infected with viruses.

Remedies for curing such ailments come from antivirus programs sold by manufacturers. If a computer catches a deadly virus, the entire computer itself can suddenly be rendered useless and crash (fall ill).

10) Third Eye: We use third eye to communicate with Spirit world, and a computer uses a modem to enable it to upload/download data in cyberspace.

- 11) Cells: When replicating themselves, our cells undergo the process of mitosis (1 cell, 2 cells, 4 cells, 8 cells, 16 cells, etc.). For a time, a computer's memory increase increments also followed the same numerical pattern as mitosis (...4 Megs Ram, 8 Megs Ram, 16 Megs Ram, 32 Megs Ram, 64 Megs Ram, 128 Megs Ram, 256 Megs Ram, 512 Megs Ram, etc). Past the one Gigabyte mark, these numbers no longer directly correlate with the mitosis numerical pattern.
- 12) DNA: As previously demonstrated within the Pi chapter, computers assimilate and process data in the form of two digits (the numbers 1 and 0) in various combinations. The DNA double helix, much like the 1/0 digits found within computers, operate on much the same basis - both translate to huge variations of genetic possibilities simply through the rearranging of a few main building blocks (four nucleopeptides).

- 13) Sexuality: Besides being spiritual beings, we are also highly sensual by nature whether we express it through cooking, art, music, literature, dance, or through the body itself. Depending on the user's intent, a computer connected to the World Wide Web can express its sensuality by visiting erotica or porn websites and chat rooms. Type the word "sex" in any search engine for example, and listings for hundreds of thousands of sites will appear. Chat rooms also flood the World Wide Web, and people can disguise their gender and age and assume any identity they desire should they choose to do so.
- 14) The Ability to Learn: When we want to learn something new, we read a book, surf the Web, or have someone teach us about whatever we wish to learn. A computer learns new material by having it uploaded into it via software. (This trait will greatly improve if Artificial Intelligence ever becomes a

reality, since computers will then teach themselves without our aid.)

- 15) Fire Element: The Fire element keeps our body temperature constant at 98.6 degrees F. A computer needs electricity to keep it going.

#

Yes, more links us with computers than we realize. In fact, considering how fast they are evolving, computers might well end up becoming this planet's super species and take over. It sounds incredible, but the possibility is there.

As long as humans continue to run amok in their thoughts and actions, the World Wide Web will continue to exist as humanity's technological wild card. In the future, the World Wide Web will be seen only as benevolent as we are with each other and our surroundings. It would therefore be in our best interest to seek to control our dark side as best as we can. The World Wide Web will pick up on our change in behaviour and follow our lead.

Are you shocked then by the World Wide Web's true nature, the idea that it is a technological representative of the global human mind? Does it scare you to think that it can help save humanity as well as destroy or enslave it? Like the names of the famous people we have just looked at earlier, the World Wide Web also has the power to give or destroy life. It is neither good nor bad, but it can be known as such depending on our intent when using it. Since the ball of the mouse is in your court whenever you venture online, it is up to you to choose whether you want to raise your awareness by exploring the World Wide Web's positive aspects, or drain away your power by falling into the web's many traps and pitfalls. Computers are simply tools, and so is the World Wide Web. For that matter, so are we.

Personally, I feel that the World Wide Web will continue to evolve, then it will either be transformed dramatically into something positive for our growth or it will simply crash and burn - die off - by some unknown mechanism or event. Either way, a new phase of human growth will be

jumpstarted. We will eventually realize that before the World Wide Web was even born, a better and more powerful one once existed and is still within our grasp. It exists within the heart and mind and links every person, element, plant and animal species in the Universe with each other.

I believe that the World Wide Web is slowly training us to re-attain this more powerful consciousness. As preposterous as it may seem to suggest, we are still taking baby steps when it comes to reclaiming what we have lost so long ago. As a world, we are on the verge of entering our teen years.

In regards to the number 9's dual nature of both savior and destroyer, it also demonstrates one very important lesson: every spiritual master that has ever existed had the potential to be extremely evil. With his charisma and knowledge of International law, Gandhi could have led his people on a destructive path, possibly raising national anti-British sentiment to the point of creating major armed conflict. And had the Nazarene listened to his mortal self

instead of keeping his focus on humanity's potential, he may well have become our greatest enslaver. Remember, the taller the person, the longer their shadow.

Tame the beast. Accept your dark side as it is an integral part of you, but keep it under restraint and on a tight leash so that it will not hurt you or others. Walk in balance, seeing everything as part of a greater whole rather than segmented, and you will begin to realize who you really are. A hero. Champion of champions.

ALIENS AND UFOS

Re-uniting With Our Long Lost Family.

Catch the scene.

10:15 PM on a mid-July evening. Mercury levels are jammed at a searing ninety-five degrees Fahrenheit. On a dirt road somewhere in the remote West Virginia countryside, a caramel colored station wagon quietly makes its rounds. The vehicle periodically slows down, speeds up, and slows down again.

Poachers? Punks up to no good?

No. Just an amorous young couple looking for a place to "park".

"Tim," says the southern belle with long auburn hair, "over there by that tree, that looks like a good spot, don't you think?"

"Yeah, it looks all right," her boyfriend replies as he successfully dodges another pothole in the road, "let's check it out."

The car banks left, coming to a rusted metal gate decorated with a lopsided and shotgun riddled "No Trespassing" sign. The gate is tied shut with a large frayed poly rope and half a dozen knots. Tim is about to step out when Sue-Ann grabs his arm.

"Don't worry," she says, "I'll get it."

Sue-Ann unties the gate and waves him through - all in less than six seconds. She then shuts and ties it again behind him. Tim smiles as wonder woman jumps into the car.

"That was fast," he says with a smirk on his face, "you have any other abilities I should be aware of?"

"Wouldn't you love to find out," she teases back.

Our romantic twosome could not have picked a better spot for their adventure. Town is a memory now and the heavens - millions of them - shine in full force.

As the station wagon comes to a halt beside the lone tree, Tim kills the engine, puts the keys on the dash, and rolls the window down halfway. Leaning into his seat, the vinyl upholstery makes a creaking sound. Nearby crickets immediately stop chirping, wait, then start up again.

"Good choice," Tim remarks.

Sue-Ann nods her head in agreement.

"It's beautiful."

Where they have stopped is on top of a small hill overlooking a large grassy field. Directly ahead in the distance lies the tree line. To the left are the sounds of a gargling brook. To the right are rolls and rolls of discarded barbed wire fencing, shining in the moonlight. Fireflies, bullfrogs, and the occasional hooting of a barred owl complete the scene. Except for the wire, one could not have

asked for a better picture. Straight out of a fantasy novel is what it looks like.

"Are you warm enough?" Tim asks, realizing only afterward how silly the question sounds considering the heat.

"Yes, I'm fine," Sue-Ann laughs, "thanks for asking though."

A brief moment of awkwardness ensues. Young hearts ache over who will make the first romantic move. From observing these two, you would never guess they have been dating for almost a month.

Feeling playful, Tim starts whistling a happy tune. He makes a puppet with his fingers and walks the little two-legged "Romeo" down the seat towards Sue-Ann's hand. The puppet stops halfway, and waits.

Sue-Ann giggles and lets her fingers do the walking. As "Juliette" reaches her suitor, the two slowly mingle and intertwine. Delighting in what they see, Tim and Sue-Ann

gradually follow the cue and lean into each other, initiating a ritual older than time itself.

Ahem.

Let us not invade their privacy any further, ok? We know what is going on and why the windows are fogging up. We will just fast forward time a little. I think they would like that (well, actually, they might indeed like an audience, but this is not that kind of book and I seriously doubt you are that kind of crowd).

Ok, it has been two hours. That is probably long enough. Let us see what our two lovebirds are up to.

Yes, just as suspected: it is the afterglow.

Tim and Sue-Ann are on their backs, resting their heads on the station wagon's opened rear door and looking at the stars above. They occasionally whisper sweet nothings into each other's ears while talking about spiritual beliefs, future plans, sexuality, and life in general. In other words, they are talking about the mysteries of immensity.

But something is amiss.

For some reason, the crickets that chirped so loudly before are now quiet - as if they have ceased to exist. The air feels colder too. Everything is silent and still.

Sue-Ann looks past Tim's face into the distance and sees something.

"Tim..." she whispers nervously, "what's that?"

Tim turns his head and spots a yellowish glow silently traveling above the treetops.

"Sssssh, I don't know what it is, but don't move or say anything!"

The kids stare helplessly as the strange looking light floats across the field. They hope with all their heart that it will pass by and leave them undetected.

No such luck.

Like an arrow, the light suddenly shoots upward from the trees and towards them, stopping less than a hundred feet above their heads. The fiery orb just sits there like it is watching. Gauging.

Scared out of her senses, Sue-Ann cannot contain her fear any longer.

"TIM!!" She cries while shaking Tim's shoulder as hard as she can, "I DON'T WANT TO STAY HERE - I DON'T! LET'S LEAVE RIGHT NOW!"

"I KNOW - I KNOW - DON'T WORRY," he yells in return, "WE'RE OUT OF HERE!!!"

Tim scrambles out of the blankets and rushes towards the front, but some unseen force jerks him violently out of the car and onto the ground.

Sue-Ann becomes frantic.

"TIM!!" she screams. "GET UP! PLEASE DON'T LEAVE ME HE..."

Before Sue-Ann can finish her words, she goes sailing out of the car as well, landing by Tim's side. Stunned and confused, the youths slowly prop themselves up on their hands and knees, finding that their sense of time, vision, and sound has become stroboscopic.

Various light images are caught frame by frame.

Human looking shapes come out from within the strange looking object and run towards them. A long, hairy foot is seen in one frame, a naked smaller gray one in another. The forms seem huge and small, thin and wide, luminous and dark all at the same time. Language is heard in choppy bits. The smell is both foul and sweet. Something touches their skin. A rising - almost floating - sensation is felt, along with the passing through of a solid wall by the body.

And then everything turns dark.

Tim awakens, finding himself naked and lain flat out on a table inside a brightly lit room. Though not strapped down in any way, he feels like he is held by some unknown yet gentle force. He also spies a counter off to the left.

Voices are heard. They seem to be both in Tim's mind and outside of him at the same time.

"No way," he exclaims, "this isn't for real! This isn't reality! I can tear myself away from this table!"

Tim struggles with all his might, but finds that the more he fights to sit up, the harder it is to move. He is trapped.

The voices become stronger. Beings lacking true form appear off to the side. They are talking to him. They are him, they say.

"What?!" Tim mentally exclaims. One is here and there at the same time? Impossible!

The voices continue talking. They speak of commitment, remembering, and love. They say that people are responsible for each other and must resolve conflicts peacefully.

A feminine being with an odd but appealing type of beauty is then sensed. Her eyes...those eyes...Tim cannot look into them. They are too intense. Her voice becomes seductive. Warm feelings in Tim's lower regions are felt. Sexual feelings rise...the feelings get warmer...

"Hey - no - wait!" he shrieks.

The space age *femme fatale* casually disregards Tim's loud protests, continuing on with her "investigation". As she

goes deeper into Tim's groin area, Tim suddenly starts rolling his eyes.

"OH...Oh...oh...oh my...oh my...GAAWDD!!!"

Black out again.

Tim reawakens. He is still naked and in another room, this time with two entities standing on either side.

The room is more open than the last - clearer as well. Businesslike, like a boardroom. There is a screen at one end. Images dance on it. Environmental problems, wars, kids running around...playing cops and robbers and shooting toy guns, racial intolerance, unevenly distributed wealth...lonely people with gray hearts...looking for company and understanding...

"Why are you showing me this," he exclaims to one of the beings, "and where is Sue-Ann?!"

"There is a need for change, renewal and awakening," says one of the entities calmly, "we are hoping that by showing you the way things are from a distance, you will wish to make a difference. You have forgotten how

connected you are to each other. And do not worry about your friend, she is in another area. She is not harmed."

Tim's mind does not register the entity's words. He turns to the other one, wanting to ask another question. More than that, he wants to see if Sue-Ann is safe. He is about to put up a fight, but the beings sense this. Tim feels his knees start giving out from beneath him. He never even feels himself hit the floor.

Tim's girlfriend is the first to wake up. She sits upright inside the rear of the station wagon and glances out the window. The sun's bright rays kiss the land. A male cardinal flirts about in the shrubs, and two crows create ruckus in the field below. She quickly checks herself in the mirror while Tim grunts himself awake.

"Um! Aragh...ungh...uh...sigh...morning gorgeous..." he says while scratching his messed up hair, "quite a night huh?"

"Yeah, it was," Sue-Ann says with a grin while reaching for the hair brush in her purse. "Listen, we've got to get out

of here before someone sees us. We're going to be late for work and I don't want to meet the guy responsible for that sign's condition back there."

"Yeah...you're right," Tim murmurs, "let me get dressed first."

Sue-Ann spots something peculiar on Tim's left side as he fumbles around for his clothing.

"Tim," she remarks, "what's that red spot? It looks painful. I didn't hurt you there last night, did I?"

"Huh - that does look weird, I don't know what it is. Maybe a tick bit me or something."

Tim's girlfriend becomes agitated.

"Well if it is a tick bite, you'd better have it looked at. Geena's dad barely escaped from Lyme disease last year. He had a sore that looked just like yours and he didn't do anything about it until it was almost too late!"

"Ok ok - I'll have it looked at today then," he says to calm her down. "By the way...where's my other sock?"

Sigh.

Couples.

Tim and Sue-Ann are in the front seats. Time to scam out of there before someone comes around. Tim slides the key into the ignition, hoping he will not have to pop the hood again in case it does not start.

The engine roars.

"Cool," he thinks to himself, "on the first try too!"

Tim shifts the car into reverse, backing up to face the trail they came in on last night. As they near the closed gate, Sue-Ann puts on her jacket and shoes.

"Tim, I'll take care of it again ok?"

"Sure," he replies, "if you really want to, I guess."

Sue-Ann winks, smiling mischievously. "Believe me," she says, "I do."

As Tim drives through the opened gate, he spots a big tom turkey and his hen standing in the field across the road. He'd love to flush them just to witness their powerful flight, but since they do not want to make themselves obvious it

probably would not be a good idea. Anyhow, he spots Sue-Ann running back to the car through the rear view mirror.

"Ok, the gate's tied, let's go," she says as she hops in and slams the door.

"You're the boss...for now," Tim says with a grin as he watches the turkeys fly away.

As they round the first bend, they see a brown tractor heading towards them. An older fellow in dark green coveralls and an orange ball cap is driving it.

"Wonder if it's his property we were on," Tim says as he sees the tractor vanishing in the dust behind them.

"I don't know," says Sue-Ann, "but if it is, he's in for a surprise."

"Really," Tim remarks, "why is that?"

"Remember the gate?"

"Yeah, of course I do. What about it?"

"Well, it's tied shut, but not with the rope."

"Huh?!" exclaims Tim.

"Look here silly and I'll show you what I mean..."

Tim looks as Sue-Ann faces him and smiles. She spreads her blouse, partially baring her chest.

He goes into hysterics.

"HAA HAA HAAAAA - YOU USED YOUR BRA?! HOOEY - I'D LOVE TO SEE HIS FACE WHEN HE SEES THAT!"

"That ought to spice his life up a bit huh?" Sue-Ann says in a smug tone while doing up her buttons.

"Yeah," Tim jokes, "maybe he'll take down that sign and leave the place open for anyone else to go there too!"

And so it is that as two friends and lovers laugh their way into town, another fine evening of romance comes to an end - until their next adventure that is.

Amazingly, neither Tim nor Sue-Ann even slightly recall last night's events. Memories will return of course, but probably only with time and through reoccurring nightmares and strange coincidences. Let us keep our fingers crossed and hope that they will support each other during their awakening. After all, from all the fun that Tim and Sue-Ann

appear to have as a team, they definitely look like they belong together.

What are UFOs and Alien Abductions?

Much of what Tim and Sue-Ann witnessed is typical of what people report during UFO abductions; strange lights, finding one's self in weird looking rooms and naked on tables, feeling examined by beings, and seeing images of environmental degradation. These are just some of the common threads of information consistent with alien abduction incidents around the globe.

Whether or not one chooses to believe or disbelieve in UFOs and aliens, one has to admit that some peculiar things are being seen out there by people. Not all of these people are average citizens either. Some are corporate executives, government officials, and diplomats. Not exactly the kind of folk one would expect to hear tales of "little gray people" from.

Specific details about the aliens encountered during abductions vary. Some abductees report seeing tall, blond hair and blue-eyed people while aboard the crafts. Others say the beings they encountered were smaller and thinner, with large eyes and grayish skin. Some report having had negative experiences while others feel neutral or positive about theirs. There are also the infamous cattle mutilations reported every year.

We are not going to categorize all abduction episodes and provide a list of UFO abductee related organizations. This book was written with a different purpose in mind.

My people have a different view of what the dominant culture calls "aliens" and "UFOs". For the most part, aside for secret and reverse engineered craft developed by rogue elements within certain world governments, we consider these entities to actually be closer to Spirit Beings, and more importantly, *family*. These Beings possess great intelligence and are believed to possess the ability to either physically transform themselves or to "throw" pictures into our minds,

thus modifying the way in which they appear to us. They can thus appear in whatever form, shape, and texture they wish: metallic craft, slender beings with large heads and slanted eyes, tall furry creatures, spheres of light, the works.

With the near endless supply of information and disinformation circulating right now on the Internet in regards to Extraterrestrials (i.e. whether or not they exist, are they good or bad, etc.), the best and most reliable method of sorting out truth from falsehood is to do your own research and go within and trust your spirit to provide you with answers. Personally, I have felt for a long time that there is indeed a war going on within the Spiritworld and the Cosmos, and that many factions are fighting over something that is extremely precious to them: *us*. I also feel however, that, just as in the world of humans, it is but a small percentage of these Beings that are causing trouble, and that the majority of our cosmic brethren consist of *peaceful* races who wish us to evolve freely and to reclaim our

powerful spiritual birthright. If our coming here is indeed a result of a sort of cooperation between our own selves (as Spirits) and Extraterrestrials, then it is also my opinion and entirely possible that the warring factions right here on Earth are direct descendants of these factions. In other words, as horribly simplistic and naïve as it sounds, "bad" people might come from "bad" or lesser evolved Spirits/ETs, and Earth's good people might be the lineage of good or benevolent ETs/Spirits. And if religion were brought into all this, one could just as easily substitute the word Spirits and ETs with the word "Angels". Without pretending to know the intricate details of its dynamics or details, I really do believe that everyone and everything in this war is all related, and that it will come to a peak quite soon. We are living smack in the middle of some extremely important times.

Another word of caution for months and years to come would be to stay centered and open. What I mean is that your best line of defense against "evil" ETs (of which I am certain there are extremely few) and the secret agendas of

certain humans on Earth is to remain true to yourself, and to recall that you are not a mere pawn in this war. In fact, because you are the descendant of your own eternal Spirit and extremely advanced Beings from elsewhere in the Universe, you are an extremely powerful Soul. And the day that you decide to fully claim (and use) your powers is the day that every person and Being that has tried to keep you under control and fearful until now will become fearful themselves. They will lose their power.

The other thing to watch out for has to do with our tendency to automatically be seduced by whatever pleases our senses. An offworld race that might not seem pleasing to look at is not necessarily lesser evolved or less compassionate. And someone that is attractive beyond belief is not necessarily without an agenda. Remember also that, like humans, every faction has its rebels.

What I am getting to here is that these offworld intelligences should be treated like other humans: with decency, and above all, with *respect*. It is also worth

remembering that whatever created them in terms of a higher intelligence or power also probably created us as well. In that sense, despite any issues and conflicts we may (or may not) have with offworlders, we are also dealing with *family*.

On an even touchier note, it is not unfeasible to assume that since the human bloodline will most likely need new and foreign blood at some point (as it has in the past), that many races from other realms and systems in the Universe will one day blend and merge with ours. So we may be dealing with future (and possibly past) lovers as well. Heavy.

Now, before going too far off track here, there are a few places one may poke around in to see how UFO abductions may represent an encounter with ETs and Spirits. One of these places lies hidden within our international bestseller. A particularly famous group of Biblical passages within the Bible, the King James Version, has often been touted by many ufologists as possibly being an actual UFO

abduction. Analyzing these passages will also effectively demonstrate how terminology relating to the Great Pyramid was incorporated into them. Enter the mysterious realm of a prophet who lived 600 years before Jesus: Ezekiel.

Ezekiel's Vision

Again, as was the case in the chapters on the Great Pyramid, you will have to rely on your intuition to understand what Ezekiel was talking about. A fair percentage of what he saw has to do with the Great Pyramid (remember - the Great Pyramid represents us when we first came to Earth as Spirits). Step by step, we are going to present various aspects of Ezekiel's vision and give each one a run down.

Here is the first passage:

Now it came to pass in the thirtieth year, in the fourth [month], in the fifth [day] of the month, as I [was]

among the captives by the river of Chebar, [that] the heavens were opened, and I saw visions of God.

Ezekiel 1 v.1

The word "heavens" in this passage is simply another word for chakras. In esoteric jargon, the chakras are often called the seven "fires, heavens, veils, vials, seals, angels, wheels, churches, temples, candles, or spirits". And to Ezekiel they were "opened" implying that just like how a crystal healer helps open up a person's chakras, the same event was taking place for Ezekiel.

Okay. So first, Ezekiel undergoes an opening of his chakras and sees visions of God. What next?

And I looked, and, behold, a whirlwind came out of the north, a great cloud, and a fire unfolding itself, and a brightness [was] about it, and out of the midst thereof as the color of amber, out of the midst of the fire.

Ezekiel 1 v.4

Ezekiel's "great cloud" and "fire enfolding itself" with a "brightness" correlate well with the ball of light seen by the young couple at the beginning of this chapter. These portrayals are simply ways in which Spirit chooses to show itself. Again, if Spirit wanted to show itself as a burning bush, a chariot of fire or whatever, it could have done that too. Spirit can show itself in any manner, size and shape it wants. Spirit also could have chosen to reveal itself as a huge alien mothership or a flying saucer. Spirit presents itself in ways just on the edge of what we are prepared or willing to accept.

One interesting aspect however, is that a great percentage of UFO sightings throughout the world have been described as being either luminous or fiery in nature. That is because Spirit *is* luminous and fiery in nature. After all, Solar Spirit *is* solar energy!

On with the next passage.

Also out of the midst thereof [came] the likeness of four living creatures. And this [was] their appearance; they had the likeness of a man.

Ezekiel 1 v.5

Without overcomplicating things any more than they need to be, we will just retain the fact that these four creatures basically imply that they are like a human being.

Now here is where Ezekiel threw in an obvious clue enabling us to decode and understand his vision;

As for the likeness of their faces, they four had the face of a man, and the face of a lion, on the right side: and they four had the face of an ox on the left side; they four also had the face of an eagle.

Ezekiel 1 v.10

No immediate connection is apparent here between the four "faces" mentioned by Ezekiel and the typical UFO sighting per se. This bit of information does nevertheless pack a solid punch in terms of how it relates with the Great Pyramid.

In order for us to understand what Ezekiel meant when he talked of the presence of these four "faces", we have to get back into astrology and more specifically at what a "fixed mode" is.

Besides astrology's four elements of Earth, Air, Water, and Fire, there are also three "modes" of signs: mutable, cardinal, and fixed. Within the fixed mode are four signs. These are: Scorpio, Aquarius, Leo, and Taurus. These four signs are called "fixed" because that is exactly what they are: fixed. No, I do not mean the kind of "fixing" that takes place at the veterinarian (ouch). I mean fixed as in "fixed in place". Stubborn. Obstinate. Unchangeable. Pig headed.

People born under these fixed signs usually will not budge an inch in their characters and decisions unless they

want to. Nobody can influence them, not unless they decide themselves to heed advice from others or unless Spirit starts giving orders.

So what do these fixed signs and the Pyramid have in common? Let us take a little spin on the Great Pyramid and find out. Better yet, let us take the Pyramid itself for a spin and see what will not shake loose.

In your mind's eye now, suspend the Great Pyramid from the apex with a string, and spin it.

Notice as how the Pyramid gyrates and swings all over the place, that only the top remains relatively still and centered. You could even say that the top of the Pyramid is rather "fixed" in place.

That is exactly where the fixed signs of Leo, Aquarius, Scorpio, and Taurus are. They are right up at the top of the Pyramid where third eye is. And what are these sign's archetypes?

They are: a lion, a man pouring a pitcher of water, an eagle, and a bull (or ox).

The four creatures of the apocalypse.

These four Biblical creatures hardly seem sinister if their meaning and presence within the Pyramid is interpreted correctly.

If you were a prophet having lived thousands of years ago and faced the challenge of hiding sacred knowledge for future generations, you would have used coded language. The encryption method would probably have been in the form of mathematics or symbols, in Ezekiel's case, he used astrology.

So you see, these four creatures are actually code language terms used to designate our third eye. These four creatures live at the top of the Great Pyramid's apex, where the capstone's "eye" is found.

An additional mentioning of third eye in astrological terms is found within in John's Revelations as well. In this book of the Bible, John undergoes a similar experience to Ezekiel's.

And the first beast [was] like a lion, and the second beast like a calf. And the third beast had a face as a man, and the fourth beast [was] like a flying eagle.

Revelations 4 v. 7

Here, John is carried forth into the presence of Spirit by means of the four creatures (third eye) and is told to warn people of the impending dangers and plagues.

As for UFO abductions, any mentioning of the third eye by abductees is scarce indeed. I have never found any evidence of it in abduction anecdotes anywhere, except if you consider how many times abductees state they have a hard time looking directly into their captor's eyes. Could the alien's eyes simply be another mask for third eye? Maybe.

Anyhow, when Solar Spirit decides to come in for a visit, third eye is going to be reactivated whether humans like it or not - or even if they are aware of it or not. In the game of life, it is Spirit who calls the shots.

On we proceed to the next passage.

The appearance of the wheels and their work [was] like unto the color of a beryl: and they four had one likeness: and their appearance and their work [was] as it were a wheel in the middle of a wheel.

Ezekiel 1 v.16

To grasp the meaning of the phrase "wheel in the middle of a wheel", we need to not only talk a little more about the Pyramid but also about astrology and how it relates to the concept of time as we know it.

More astrology lessons.

Who has not heard of the "Age of Aquarius" at some point in their lifetime? Aquarius the eccentric and offbeat sign of the Zodiac feels right at home in today's fast paced times. The Internet, denim clothing (trademark clothing material for rebels and eccentrics - hey, it was there in Woodstock), space travel, new age spirituality, alternative lifestyles and sexuality, vegetarianism, science as near

religion, and meditation are all indications that we have entered the kooky Age of Aquarius. As a matter of fact, nearly everything about our current social world is a far cry from what it was just thirty years ago. Heck, the world has changed tremendously from even five years ago.

Everything about the Age of Aquarius is different from the more dreamy, mystical, traditional and God fearing age that preceded it: Pisces, the sign of the two fishes.

Pisces is the astrological age that Jesus is said to have brought into the world two thousand years ago, thereby releasing Pisces from the Age of Aries' stern iron grasp. This is why when he was asked if he had come to bring Peace on Earth, Jesus said;

Think not that I am come to send peace on earth: I came not to send peace, but a sword. For I am come to set a man at variance against his father, and the daughter against her mother, and the daughter in law against her mother in law.

Matthew 10 v. 34 – 35

In other words, relating this to today's times, even though it appears that no single spiritual messiah is leading the way (are we all leading the way perhaps?), an undeniable "split" is still going on between the older generations and the more liberal and younger ones.

Part of the reason why humanity faces so many social, monetary, and religious issues at the end of every astrological age is that "old school" authority figures and leaders of the past age resist changing their ways. They do not mean to do it, but they actually tend to get in the way of people in the newly arriving age from living their own lives. These people need to gently release themselves from the old

age's mind set in order for the next age to begin (it always does anyway, so their resistance is pointless).

Think of a color overlapping another color and trying to separate itself from the other. That is what the astrological ages are like.

Please, reflect on the mechanics involved here.

From the Age of Aries to Pisces, and from Pisces to Aquarius. And then two thousand years from now we will be entering Capricorn. And then Sagittarius in another two thousand years, Scorpio, Libra, and so on.

Did you notice how the astrological ages run backwards in relation to how they occur during a normal calendar year?

We have just arrived to the significance of the words "wheel in the middle of a wheel".

The wheel of the Ages runs counter clockwise in relation to the Zodiac, while the astrological signs run clockwise in accordance with the Zodiac. They are as gears, or like a *wheel inside a wheel*.

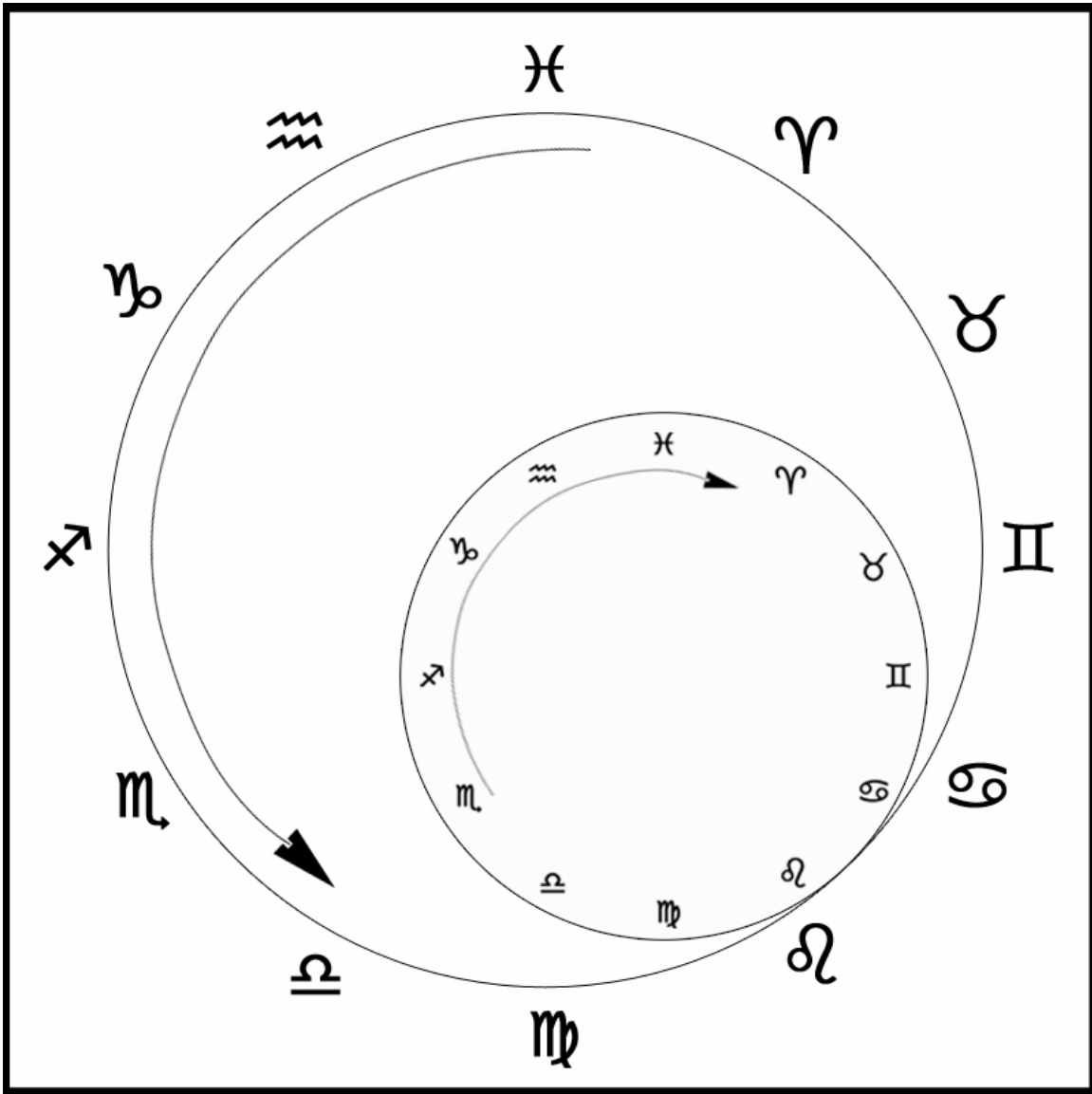

Figure 25. Astrological Wheel within a Wheel.

We will place both this and the next passage together in order to further analyze Ezekiel's vision:

As for their rings, they were so high that they were dreadful; and their rings [were] full of eyes round about them four. And when the living creatures went, the wheels went by them: and when the living creatures were lifted up from the earth, the wheels were lifted up.

Ezekiel 1 v.18 – 19

Whithersoever the spirit was to go, they went, thither [was their] spirit to go; and the wheels were lifted up over against them: for the spirit of the living creature [was] in the wheels.

Ezekiel 1 v.20

Once again, the "eyes" that were all around the "rings" so "high" and "dreadful" are another example of how these eyes clump together as one on our Pyramid, which is a dreadfully high structure, to form a single all seeing third

eye. Wherever Spirit decides to go, we have to go along with it. Spirit is the boss, so why resist?

This next passage uncovers another set of clues for us:

And above the firmament that [was] over their heads [was] the likeness of a throne, as the appearance of a sapphire stone: and upon the likeness of the throne [was] the likeness as the appearance of a man above upon it.

Ezekiel 1 v.26

Here we have two important elements:

- 1) A Sapphire stone. Sapphire is the hardest of the oxide crystals. The Great Pyramid also represents a crystal. And of course, we have crystals in our bodies.
- 2) A throne. Who sits on a throne but royalty? A King and a Queen. The Great Pyramid also contains the King and Queen's chambers. Symbolically speaking,

these fuse together as one and become an androgynous being - just as we once were.

Let us continue on with Ezekiel's vision. In the next passage, Ezekiel states how he saw that:

As the appearance of the [rain] bow that is in the cloud in the day of rain, so [was] the appearance of the brightness round about. This [was] the appearance of the likeness of the glory of the LORD. And when I saw [it], I fell upon my face, and I heard a voice of one that spoke.

Ezekiel 1 v.28

Whatever state Ezekiel found himself in, what he saw were the seven rainbow colors. These of course, are also found within us in the form of chakras. Thinking of the Great Pyramid as a giant crystal that divides light, the

Pyramid also contains chakras. The power that Ezekiel witnessed awed him and made him drop to his knees in worship.

Ezekiel was right in the grip of Spirit, and Spirit did not just want to visit Ezekiel, Spirit had other plans for him.

Then the spirit took me up, and I heard behind me a voice of a great rushing, [saying], Blessed [be] the glory of the LORD from his place.

Ezekiel 3 v.12

And this journey of Ezekiel and Spirit progressed onward, with Ezekiel realizing:

[I heard] also the noise of the wings of the living creatures that touched one another, and the noise of the wheels over against them, and the noise of a great rushing.

Ezekiel 3 v.13

Ezekiel by now was in full flight with Spirit's "UFO", and Spirit:

...lifted me up, and took me away, and I went in bitterness, in the heat of my spirit; but the hand of the LORD was strong upon me.

Ezekiel 3 v.14

The phrase "...and I went in bitterness, in the heat of my spirit" appears to suggest that Ezekiel found that he simply had no choice but to go along with Spirit in this "abduction". Like it or not, Spirit had a mission for him, and would not take no for an answer.

Anyhow, after the "trip", Spirit began revving down and Ezekiel found that he:

...came to them of the captivity at Telabib, that dwelt by the river of Chebar, and I sat where they sat, and remained there astonished among them seven days.

Ezekiel 3 v.15

And so here we have the story of a man who had his chakras opened up and was taken by Spirit. Spirit then "dropped" him in another land for a mission. In short, a UFO (Ezekiel's own Spirit) abducted him. For the most part, unless they are secret crafts designed by the military or actual residents from other solar systems and galaxies, UFOs around the world are actually Spirits.

Heck, to make it twice as easy for us to make the connection, Ezekiel himself even used the word Spirit.

No Need to Run

Because of fears fed by media hype and disinformation, the concept of Spirit and Extraterrestrials appears malevolent to many of us - as an "alien abductor" that takes us against our will. Many perceive Spirit as a wildlife biologist in a helicopter chasing us down and dropping us with a drugged dart. We are like that animal trying to run away. We are like virgins running away from their first sexual experience. We want to meet up with Spirit and experience all the love and power, but are deathly afraid of it at the same time. Surrendering to Spirit feels too much like being asked to jump off a cliff and hoping to get caught. Or like falling in love.

So trust and faith issues need to be dealt with on our part before a Spiritual connection can be made. Maybe some emotional and physical healing needs to happen too.

Certain elements within the UFO abduction experience may change, since Spirit can choose to portray itself in any way and do whatever it wants. The common theme

however, is that Spirit "drops in" on us, "sucks us up" into its reality and out of ordinary earthly realms, and takes us, if need be, to another place and time. Whether the visit is abrupt or gradual depends on our spiritual awareness.

Some abductees, perhaps like Tim and Sue-Ann at the beginning of this chapter, choose to believe the media hype about extraterrestrials and see them as being evil and hell-bent on kidnapping humans for torturous experiments and surgical procedures. Those who prefer believing in more peaceful scenarios see star visitors as peaceful beings with great beauty and as teachers of humanity.

More than a few reports have also trickled in regarding abductees who said that they have had sex with these beings, and that at times, it even felt as though these beings were soul mates.

For many children, Spirit might visit as "little people" dancing around the forests and fields. Some might see "leprechauns" sitting on tree branches outside their windowsills. The physical form that Spirit assumes depends

on how we perceive life and how much fear we have for the unknown. Fear not, and you will probably see pleasant looking beings. Believe all the hype created by society's opinions about what UFOs and aliens are, and your experiences might seem frightful.

And so you see, many reasons exist to believe in extraterrestrial life, and absolutely no reason to fear it. Everyone in the entire Universe is intertwined and connected as part of an immense marriage with occasional intergalactic visits being both allowed and encouraged. We may feel scattered from one another at the moment, but the connections between us all are still there - undiluted and as strong as they have ever been.

Yes, I know that the Earth can seem like a lonely place to live in at times. People here tend to be a bit colder than how they are in the Light, but the love within is right below the surface. Sometimes all it takes to bring it out is a smile.

Take heart. Spirit loves us deeply and will always take us back in. Have you not heard? That is just how the Circle is.

CONCLUSION

Something unexpected happened to me since I first started writing this book many years ago; it is that my fascination for Egypt's Great Pyramid has lessened rather than increased.

Do not get me wrong. I still respect the Great Pyramid as well as the Egyptian culture built up around it. Whoever created the Pyramid must have had an incredible depth and breadth of knowledge in a wide variety of disciplines. Whichever way one looks at it, the building is a masterpiece – a work of pure genius.

Since discovering that the Pyramid was built to represent us however, I have become much more *blasé* towards new archaeological findings concerning the Pyramid and the Giza plateau. In fact, if an all expenses paid trip to Egypt were offered to me tomorrow, I wonder if I would even take it. The ticket would probably end up being given to a friend or relative instead. I just don't feel the answers are there anymore. Because of what it has taught me regarding its nature and purpose then, the Pyramid has become (to my eyes at least) nothing more than a huge mirror built to reflect us.

Most of the amazing souls I have met in my travels have exemplified what it means to be open to spirit and new knowledge. Often, because of their having had tough and painful childhood experiences, they were forced at an early age to begin their healing and become spiritual seekers. When shit happens, life changes, and often for the better in the long run. Manure seems to be the fertilizer that Spirit prefers to make us grow - especially if we are stubborn and

refuse to hear and obey our inner voice. We can stay in the mess and complain, or we can dig in and grow tall to overcome the stench and enjoy the green pastures around us. Change arrives as an enemy, but if greeted head on, it is remembered as a best friend.

Speaking as a former blade of "crap grass" myself, meeting other individuals and hearing their dreams and hopes for humanity have always been great experiences. These people are so different in their characters, educational backgrounds, cultural upbringings, and beliefs. What could possibly have made them stand out from the rest, I sometimes ask myself, that life awakened them as light workers?

I suppose that is what gives being awakened as a messenger its beauty.

Spirit cares little about our faults. Spirit knows everyone's potentials and is more than willing to turn a blind eye to what others or we feel are our shortcomings. Spirit only cares about being heard and getting the message out

there to do its work. Messengers never quite equal the purity of the message anyway, so any candidate will do, provided their heart is in the right place.

This holds true regardless of whether the chosen individual happens to be a government worker, lawyer, doctor, movie star, cashier, or vagabond. What others may see as a five dollar radio may not have the same sound quality or flashiness as a fancy digital entertainment system, but the message pumped out by both speakers is identical. Each finds its appropriate audience. Become overly concerned with a messenger's appearance or behavior, and you will miss the message.

What this work has sought to do is provide a tiny glimpse of our beauty and potentials. Essentially, we have suffered from a 4.5 billion year old case of spiritual amnesia, and we seek from without what is already within.

With all the talk about life here, it becomes hard not to realize how awesome these times are. As a matter of fact, whatever century we choose to enter Earth existence in,

coming here in physical bodies is always an exciting roller coaster ride. We take our first breath when we are born for instance, our first baby steps, receive a first kiss, get our first job, marry (or not) for the first time, and have our first children and watch them grow.

We then finally take our first step out of the rat race and look at what we have learned. Then, before we know it - before we are even ready to accept it - it is suddenly time to take our last breath, close our eyes, and take a blind leap of faith into the unknown. Our Mother Earth is filled with these events and happenings. These make this planet an exciting place to come to.

Perhaps too exciting for many.

Many Spirits think twice about coming here as newborn babies. For one, they are apprehensive about diving into Earth and learning how to operate a flesh body. Secondly, Spirits give up a lot in order to come here as humans. Until death sets them free, living on Earth means no more shape shifting, flying around, traveling underwater with the ocean's

creatures, and no more telepathy and hearing everyone's deepest thoughts and desires.

Spirits incarnating as humans cannot travel through walls, or feel genuine "*eye to eye*" contact with other Spirits. They have to come here in the flesh and help people - even while having suffered spiritual amnesia themselves - make life the way it once was. This crazy adventure is akin to helping a baby take its first steps while not knowing how to use our own legs. Talk about a challenge. Only fools would have taken it on so blindly, and we have, willingly.

In short, giving all this up automatically makes anyone who comes here a hero. A role model. A great adventurer and explorer. A star in the making.

Actually, all of us are movie stars. Regardless of our looks, age, height, weight, race, social class, and fitness levels, we are universally known movie stars living right here and now within the grandest production ever made - *life*.

Do you understand now why the Universe is watching us so intensely? We took a big step in coming to Earth in physical bodies. We had it made in the Light before coming here, and it is the reason why no matter how hard and lonely it often is on Earth, we have to stick it out to the very end. It is our mission given to us by the highest of the high.

We should take pride in our roles here on Earth then, and realize how deeply connected we are with one another. We are forged from the same spiritual fire. Few differences separate us. Before we stepped into Earth and forgot who we were, love bound us as one.

This means that every person we have ever met, and have not met yet, will one day become our lovers. This goes for all the countless Star people living right now in different planetary systems within this galaxy and all the other galaxies forever and ever.

Holy guacamole...

That is almost too much to even *begin* to fathom.

And so this was DREAMING THE PYRAMID, told just for you. The same tale could have been recounted in a myriad of equally good ways, but around tonight's fire, this is the way in which it chose to be shared.

Shadows outside the lodge are lengthening. The rear end of a partridge flies by as well, signaling this session's end. Those who might want to stay around the fire and talk more can do so. I will be hitting the sack soon, but I do not mind the company for a while longer. Who knows, if you are lucky you might even catch the fire's last burning coals fade out.

Our lives are like tonight's fire; they began with a single spark, burn passionately, and will one day end in a fizzle. From where does the spark originate? Where does it go when it burns out?

In the end, despite all the insights, ideas, theories, and speculation, it appears that mysteries remain mysteries - on this side anyway.

I would like to finish off by thanking you for sacrificing your valuable time and coming here to listen. I hope this story gave you something useful for your life's mission - whatever it may be. Remember, this tale was only an interpretation of truth, and not truth itself. Spiritual understanding continuously evolves. None should take this book too literally. It is only a guide.

Oh, and by the way, before we part, I must ask you a question. My curiosity is too great.

Tell me, have you found your precious inner gem yet?

Or are we still dealing with a jewel in denial?

APPENDICE 1

THE GREATEST HURDLE

This book certainly contains its fair share of "controversial" statements, one of these certainly being that we were involved in this planet's inception.

The notion that we, along with God or the Universal Mind, helped manifest everything is not easy to take in, but it is essential to understand if we want to forge ahead and save the planet.

Recycling, planting trees, reversing global warming and driving ecologically friendly cars will not work in saving the

environment in the long term. Until we fully accept our true roles and powers, these activities are simply band-aid solutions. Merely reversing environmental damage protects future generations, but only to a certain point. Nothing prevents our children's children from repeating our mistakes and ravaging the Earth and her resources all over again. What is needed is a worldwide moral and philosophical shift in our thinking - one lasting through the ages. We must eventually realize that the reason why we must take care of the world is that we helped create it to begin with. Only this full and global realization will work to help prevent chaos from taking place again in the future. Had the Atlanteans passed this awareness to their children, perhaps they would not have suffered their terrible fate.

Still have trouble with the idea of us being co-creators along with God? Here is another scenario; if your house was on fire, would you rush in to save paintings you bought from an art gallery, or would you save the ones you created yourself and poured all of your time and energy into? It is

an easy choice for most people, yet some would actually choose financial value over invested effort and emotions. I suppose that is what makes humans unique.

Of course, the acceptance of our role in Creation does not come without danger. My prediction is that further down the road, people will divide themselves into two groups:

- 1) Some people will take full responsibility and accountability for their actions as co-creators. They will strive to become as loving parents to Creation. Their influence upon nature will be to guide it in its evolutionary path rather than direct intervene or manipulate it directly. Earth sciences such as biology and genetic research will still exist, but these will become more holistic. Rituals, ceremonies, song, art, and dance will be seen as equally valid ways to study and influence nature.
- 2) Some will choose the easier path of "tangible results via any financial, scientific, and moral means possible". Their reasoning will be that since they

helped create Earth and its lifeforms to begin with, they are absolved from moral and spiritual responsibilities and can do anything to the natural world.

Big difference between the two.

If you think people have done evil things in the past out of ignorance, wait and see what atrocities they can do once they become aware.

So, how did it happen then? How did we create everything?

Well, first of all, it is really not much different than painting, sculpting, or writing. The creative process is the same. First comes the inspiration (from a source called God, the Universal Mind, Higher Power or the Superconscious). Then comes the actual idea or blueprint. Action is taken upon this blueprint or design, and eventually something is created. It is as simple as that. So when you look at it from that perspective, Creation and Evolution are the same process. The only difference between them has to do with

our current perception of time; Evolution can occur quickly, and Creation is often a long drawn out process. It all depends on what mood the artist is in.

The rationalist must also acknowledge that while something is evolving and changing form and function, a creative process initiated and maintained by something is definitely taking place. Chaos cannot breed order. The creationist should also realize that the manifestation of an entire physical realm filled with wide varieties of life forms does not and cannot occur overnight. In order for something to be created, ideas must evolve and be perfected over time.

Another thing to realize is that during our first appearance in the Earth long ago we did not have physically dense bodies like we do now. Yet we were still able to manipulate matter - have impact within the physical world. One of the greatest scientists that ever lived (guessing who it was should not be difficult) believed that if humans ever developed their mental abilities to the fullest, they would not

need bodies. He understood.

You do not need a physical body to move matter. You do not need eyes to see or ears to hear either. Your intent - and more importantly your heart - can do these things for you instead. In the future, we will begin to understand this.

Thirdly, and this is probably the strongest point to consider, creating everything was a *team effort*. No one did it alone. Skills were required in every area of expertise. It was much like a team of specialists assembling together and creating a movie or video game. There were Spirits that possessed highly developed technical knowledge such as the manipulation of base elements, amino acids, and DNA, while others excelled in overseeing the big picture - like organizing and project development. There were also those who provided quality control and feedback (the testers). Some Spirits were blessed in the field of esthetics - the art of rendering eye pleasing visual appearance and color to things and beings. Others worked with smell, some with laws of physics and others with sound. Slowly, over time - under

the guidance of a greater mind (what we call God) - this place we now call Earth came to be.

God may be the architect, but we are the construction crew. One needs the other to get anything done.

Unfortunately for us, we fell in love with this earthly experiment. Not that living here is a bad thing, but long ago, did we possess the foresight to prevent ourselves from becoming lost in this illusion?

These concepts are interesting to ponder because you see the same thing happening today on another level. Since prehistoric times for instance, our creative abilities have returned very fast. We went from creating worlds in our minds to creating them two dimensionally in caves as paintings. We then created them with words through stories. As we developed further, we created realms within books, then, recently, we have created worlds on airwaves and televisions. Today, we are creating them virtually with the use of binary computer data and programming. In the future, once we realize that the best technology in the world

is insignificant compared to the spiritual one dwelling within us, we will consciously manipulate the quantum realm, light itself, and create worlds for us there as well. When that occurs, we will be very close to taking the final step: becoming fully aware and sovereign Spirits able to change reality and the worlds around us at will. We will have come full circle.

These brave new digital worlds to come contain nearly everything required for us to step into and lose ourselves in. Once we find a way to upload our consciousness into the global digital network and recreate ourselves digitally, we will face the exact same dangers that we did so long ago.

God created the world, and humans rebelled. Humans create the virtual world. Will our future binary representatives do the same? Only time will tell. If you think computer games are addictive now, wait until you see what is coming.

So what is one to do when faced with all this? Do we stop and simply say enough is enough?

The need for exploration and pushing the limits is powerful - too ancient and powerful a force to deny forever. The only alternative then is to go on, but with a sense of caution and more importantly, awareness. If we raise our awareness and really push ourselves collectively into raising this planet's vibratory frequency, we will come very close to recreating Heaven on Earth - our ultimate goal.

Long ago, daredevil Spirits came here and created the Earth without much thought and planning. Everything was new and experimental. It is partially the reason why life forms such as the dinosaurs quickly became as large and primal as they did. Just like the first computers, large beings do not necessarily equate refinement. Some of today's most powerful computers fit into your palm or lap. It is the same with animals throughout evolution - their size has also gradually been shrunk simply because they are built better. The divine artist is expending minimum effort for maximum yield - and wasting less material in the process.

So let us reiterate what we have learned for clarity's

sake.

This is not our home. We are not from here. We are spiritual beings who long ago decided to play around with our creative powers and fell in love with the result, thus becoming entrapped by it. Earth has become the result of this cosmic experiment. This is why we tend to mess each other over in terms of wars and other petty activities: it is difficult for a species to live in harmony with an environment and others of its own kind if it does not belong in this environment to begin with. The thoughts, actions, and aspirations become unclear. The identities and agendas, muddled.

There are populations that do know how to live in harmony with the Earth however, and they should at least be listened to. Indigenous People's teachings are both old and extremely powerful, but they require a good heart and much humility to acquire and understand. These populations have learned from past mistakes when it comes to living with the land, perhaps even painfully so.

Many Native spiritual elders believe that one of the reasons why our people are so connected to the land and nature is that we are direct descendants of peoples who played a part in the degradation and fall of Atlantis and Lemuria. Having sworn long ago to never again allow the natural world to become imbalanced, we now seek to help prevent future catastrophes from taking place. Sadly, since nations are as susceptible to karma as individuals, perhaps this is why my people have suffered so long at the hands of what we consider to be foreign government. Though the more enlightened of us do think of Caucasians as brethren, it is difficult to witness the foolish development and enforcement of domestic and foreign social and environmental policies being made on soil we once managed for thousands of years. Really, it is a bit like a young adult being forced to observe an infant about to make a serious and deadly mistake - one that may end up affecting everyone for many years to come.

Okay. That is enough about the past. Let us reflect on

the present and where our common path may lead us.

The Star Beings watch us. They watch you. Because of their close ties to Spirit, they know exactly who we are inside and out. They read minds and see the future - but never directly interfere. They love us too dearly for that.

Despite our differences, it should be possible to unite our strengths and resources and build a place worth living in. Until all of our former spiritual abilities are reclaimed, do not let yourself become complacent or jaded to life.

The human dream is not dead. It is awakening.

And it is about goddamn time.

APPENDICE 2

AN OVERVIEW OF GREAT PYRAMID TEACHINGS.

In this section, each insight and teaching concerning the Great Pyramid is showcased in an "easy to refer to" format. Return to this section of the book when you wish to have a quick glance at each of the previous Pyramid chapter's main points.

In order for this section to make any sense however, it is vital to remember that humanity is in the process of refining itself physically, spiritually, and mentally. To put it plainly, we are here to learn how to be perfect.

In our intended physical and spiritual form, we exhibit ten major qualities. These traits consist of:

- 1) The four elements of earth, air, water, and fire.
- 2) The Zodiac's twelve signs.
- 3) Blending these twelve signs into a thirteenth "perfect" sign.
- 4) Having a connection with crystals and exhibiting their properties.
- 5) Having seven chakras.
- 6) Being connected to a Higher Power (whether one wishes to call this power 'Spirit', 'God', or 'Christ').
- 7) Being spiritually androgynous (due to our being physically reconnected with a soulmate).
- 8) Having a Third Eye.
- 9) Possessing the Kundalini.
- 10) Being physically immortal.

Let us now outline once again how the Great Pyramid personifies each one of these traits.

Earth, Air, Water, And Fire

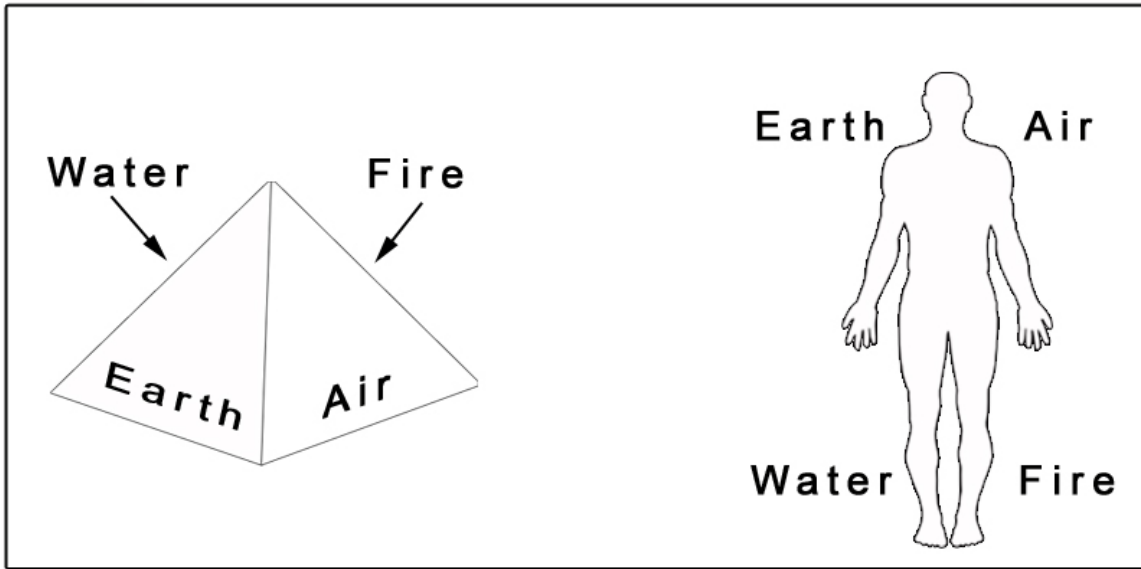

Twelve Zodiac Signs

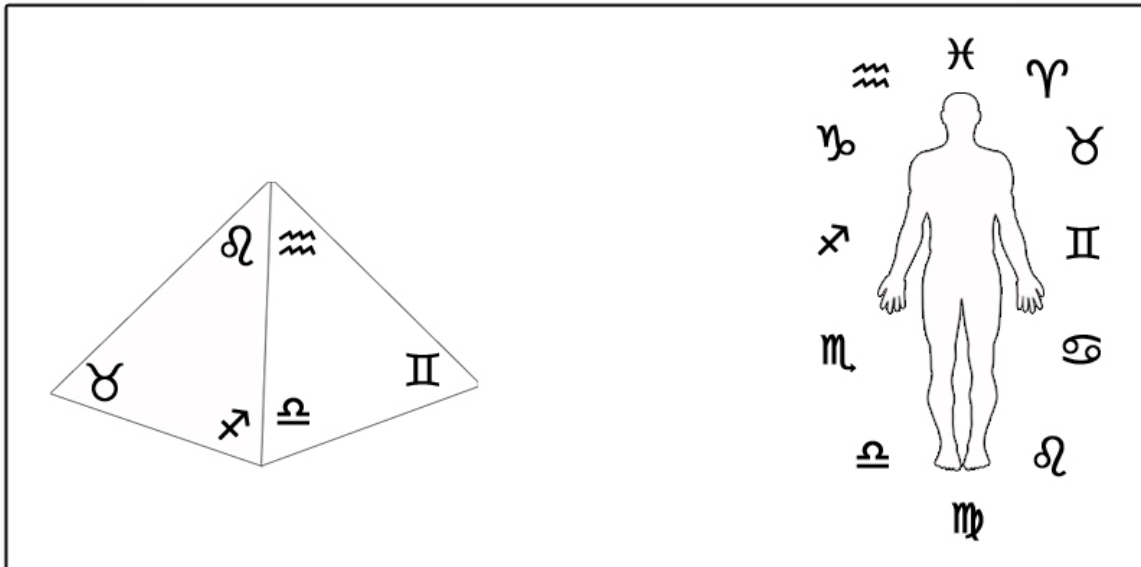

The Thirteenth Sign

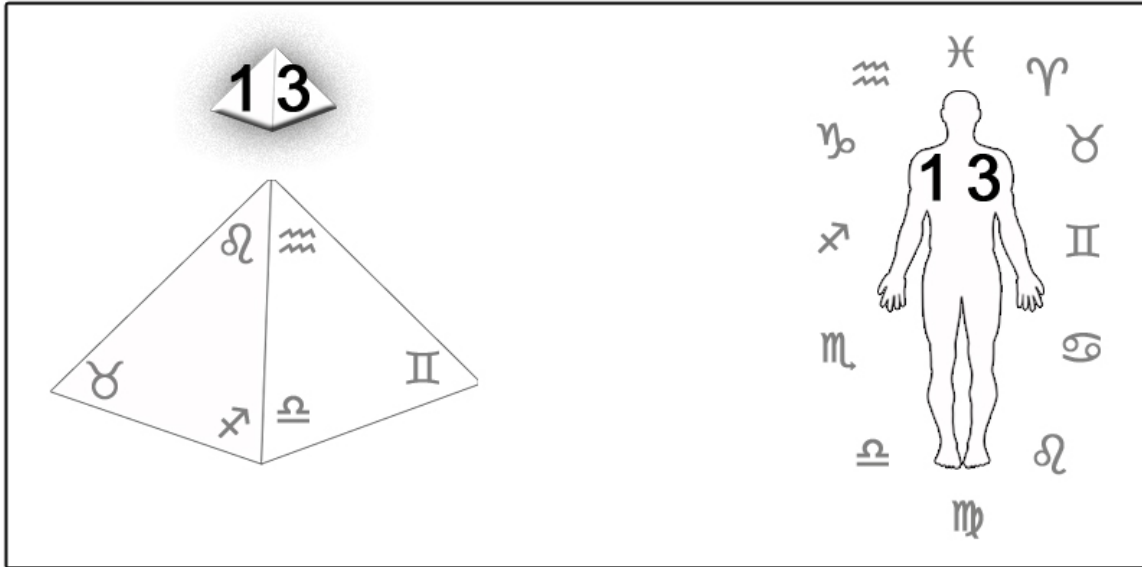

Crystals

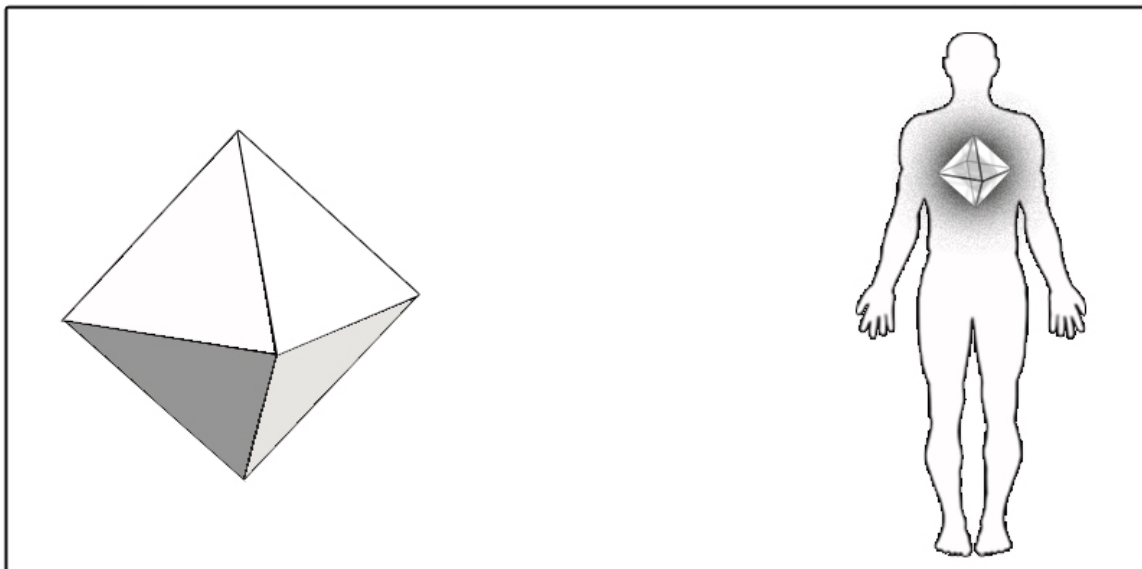

Chakras

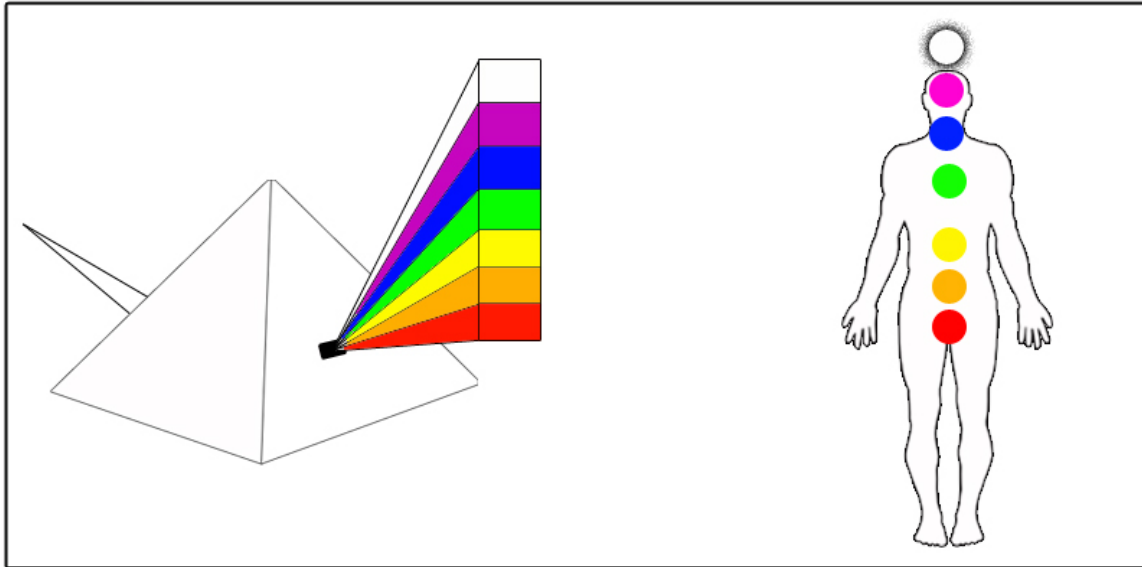

Connection with A Higher Power

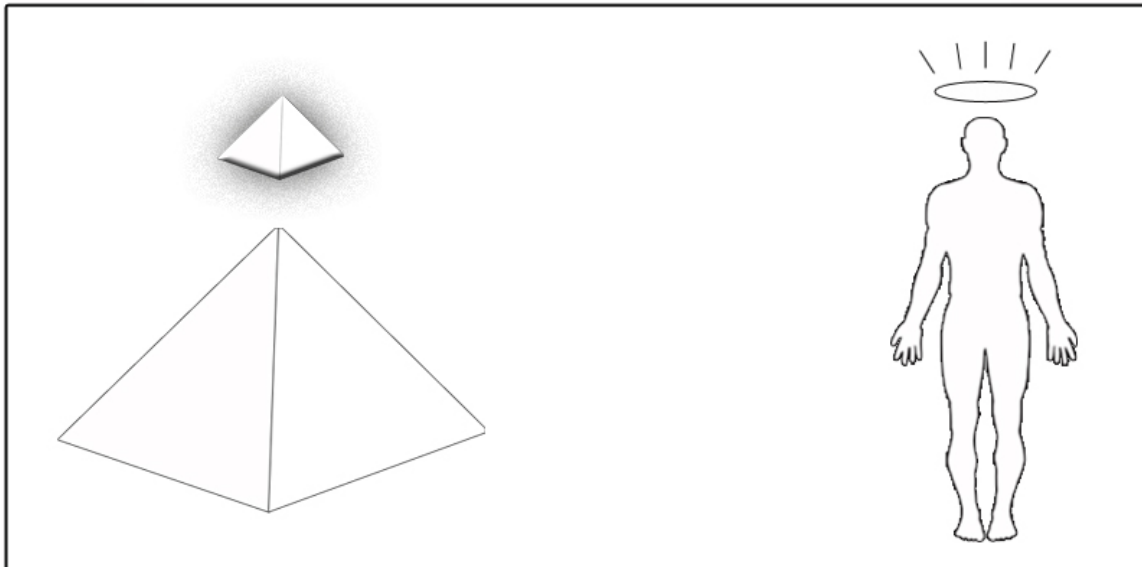

Spiritual And Physical Androgyny

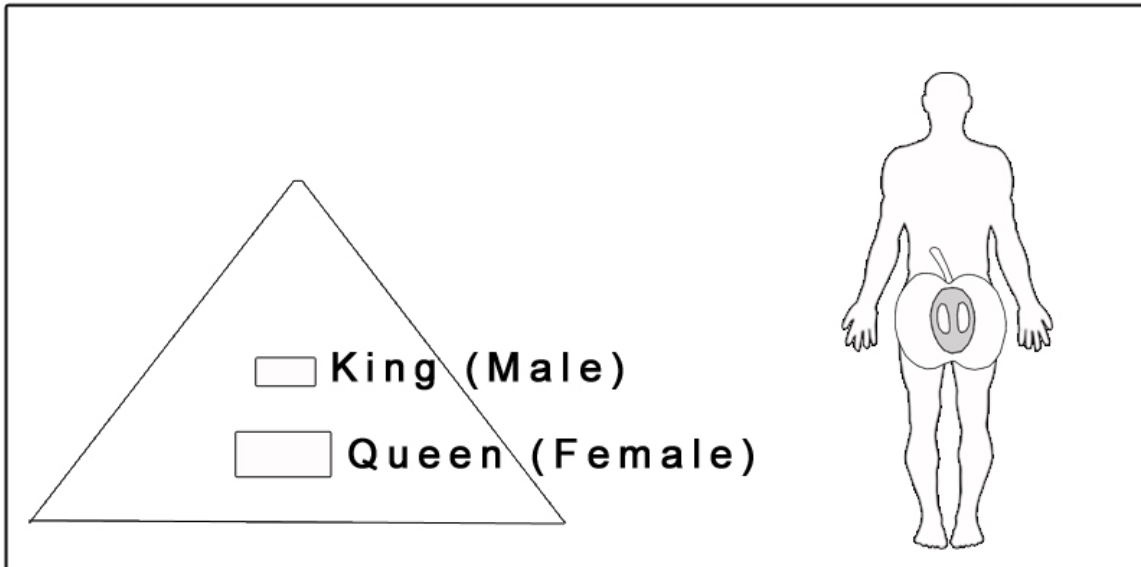

Third Eye

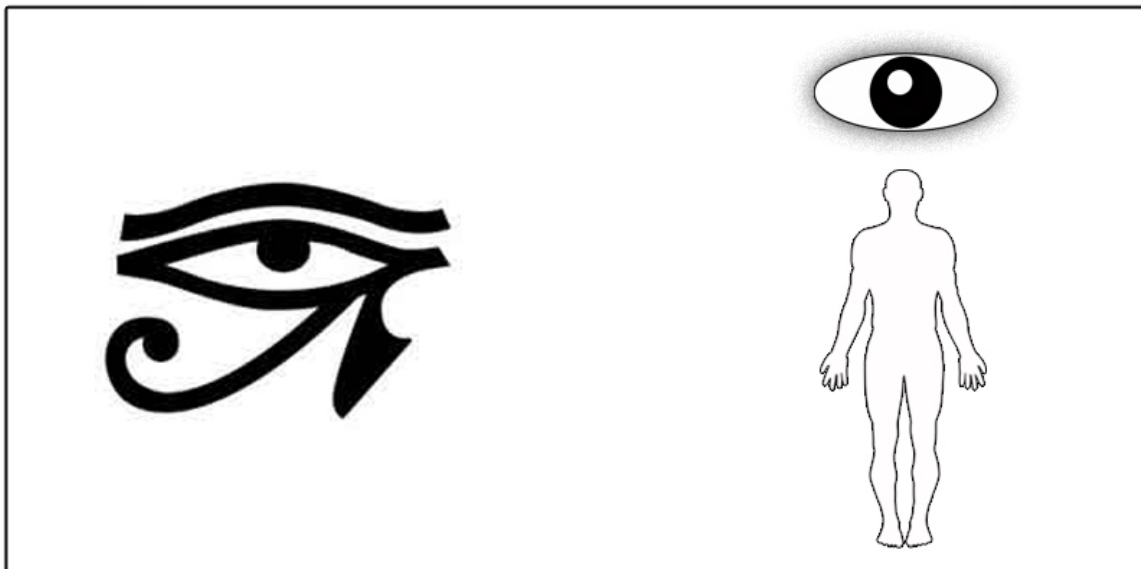

Kundalini

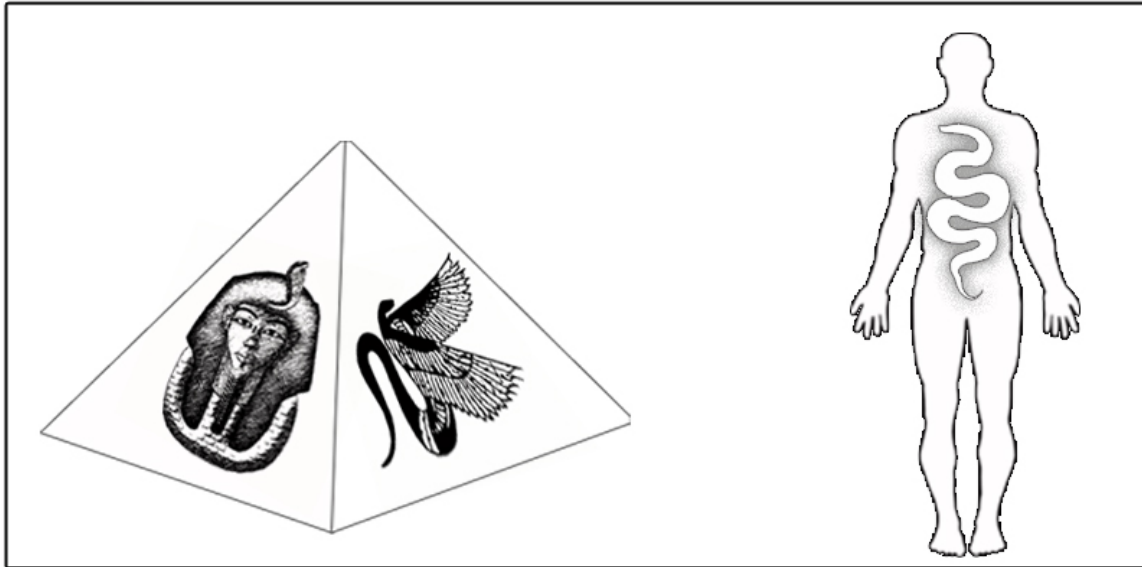

Physical Immortality

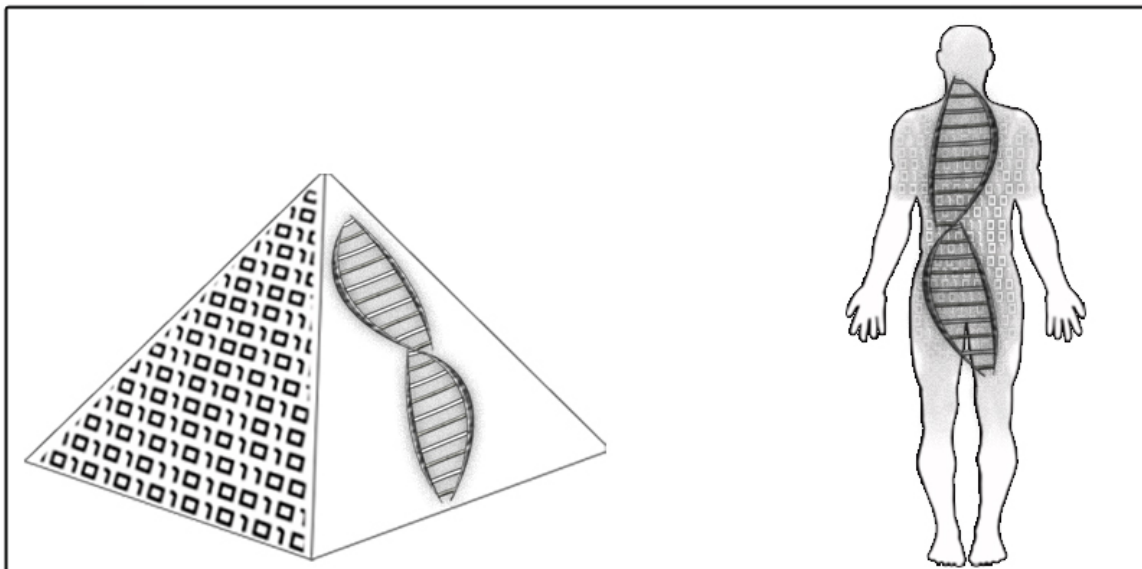

The Great Pyramid is spoken of several times within the Bible (King James Version). In the two passages below for example, the word "altar" is another term for the Great Pyramid:

In that day shall there be an altar to the LORD in the midst of the land of Egypt, and a pillar at the border thereof to the LORD. And it shall be for a sign and for a witness unto the LORD of hosts in the land of Egypt: for they shall cry unto the LORD because of the oppressors, and he shall send them a savior, and a great one, and he shall deliver them.

Isaiah 19: v 19-20

Therefore we said, 'Let us now build an altar, not for burnt offering, nor for sacrifice: but [that] it [may be] a witness between us, and you, and your generations after us.

Joshua 22 v 26

Here is another passage referring to the Great Pyramid in a clever way;

Saying, Hurt not the earth, neither the sea, nor the trees, till we have sealed the servants of our God in their foreheads. And I heard the number of them which were sealed: [and there were] sealed an hundred forty four thousand of all the tribes of the children of Israel.

Revelations 7 v 3-4

This last group of passages is interesting considering that each of the Great Pyramid's four sides is said to have been covered with 36,000 blocks of shiny white limestone. What is four times thirty six thousand? 144,000.

Incidentally, these casing stones are barely present on the Pyramid anymore. Way back in 1356, most of these were stripped off and carried over to Cairo to help in constructing fortresses and other structures. Only a portion

of the original stones exist near the top, giving the Great Pyramid its' decayed and weathered look

Also, the mentioning of sealing servants in their foreheads with a mark is a coded term for the third eye (since the third eye is traditionally portrayed as being in our foreheads). The Great Pyramid also symbolically contains the Eye of Ra (third eye) as depicted by the Great Seal of the United States.

Here is another highly encrypted reference to the Great Pyramid:

And had a wall great and high, [and] had twelve gates, and at the gates twelve angels, and names written thereon, which are [the names] of the twelve tribes of the children of Israel: on the east three gates; on the north three gates; on the south three gates; and on the west three gates. And the wall of the city had twelve foundations, and in them the names of the twelve apostles of the Lamb.

Revelations 21: v 12-14

The phrase, "And a wall great and high" equates well with the Great Pyramid's high and sloped walls. In addition, the four cardinal directions of north, south, east, and west apply to the Pyramid's four sides, which by the way, are aligned to the four cardinal directions. As for the words "gates" and "tribes", these are coded terms designating the Zodiac's twelve astrological signs, as well as, the names of all twelve disciples of Jesus. Keeping these explanations in mind, the passage's meaning becomes clearer. Let us apply

our understanding of these terms to a top view of the Great Pyramid:

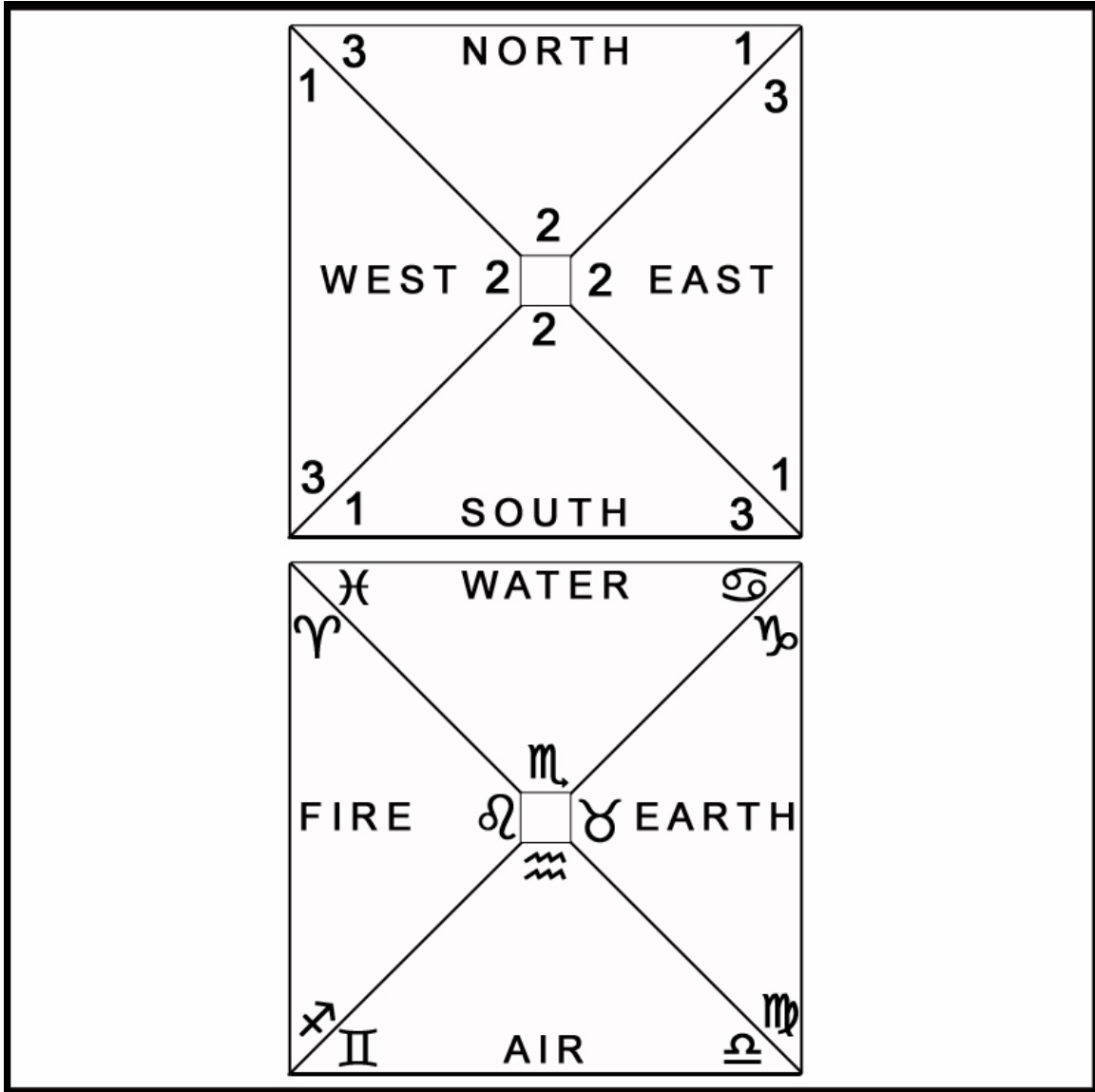

Figure 26. Two Versions of the Great Pyramid.

The Great Pyramid's invisible capstone or cornerstone is also mentioned several times within the Bible - and once even by Jesus himself:

Jesus saith unto them, Did ye never read in the scriptures, The [corner] stone which the builders rejected, the same is become the head of the corner: this is the Lord's doing, and it is marvelous in our eyes?

Mathew 21 v 42

And yet more references to the cornerstone:

Now therefore ye are no more strangers and foreigners, but fellowcitizens with the saints, and of the household of God; And are built upon the foundation of the apostles and prophets, Jesus Christ himself being the chief corner [stone]; In whom all the building fitly framed together groweth unto an holy temple in the

Lord: In whom ye also are builded together for an habitation of God through the Spirit.

Ephesians 2 v 19-22

*Who [art] thou, O great mountain? Before Zerubbabel [thou shalt become] a plain: and he shall bring forth the headstone [thereof with] shoutings, [crying],
Grace, grace unto it.*

Zechariah 4 v 7

Therefore thus saith the Lord GOD, Behold, I lay in Zion for a foundation a stone, a tried stone, a precious corner [stone], a sure foundation: he that believeth shall not make haste.

Isaiah 28 v 16

Then the LORD answered Job out of the whirlwind, and said, Who [is] this that darkeneth counsel by words without knowledge? Gird up now thy loins like a man;

*for I will demand of thee, and answer thou me. Where
wast thou when I laid the foundations of the earth?
Declare, if thou hast understanding. Who hath laid the
measures thereof, if thou knowest? Or who hath
stretched the line upon it? Whereupon are the
foundations thereof fastened? Or who laid the corner
stone thereof; When the morning stars sang together,
and all of the sons of God shouted for joy?*

Job 38 v 1-7

APPENDICE 3

DREAM LOG

Because sharing information helps us in our evolution and understanding, I thought it would be a good idea to share some of the more important dreams that inspired me to write this book. Perhaps you will relate to many of the symbols and terms here, or maybe a particular dream will help you remember your own dreams.

The "Frogman" and a Ship Lost at Sea

Dark skies, fierce winds, and stormy seas surround me. I am on the ocean and sailing upon what appears to be a

ship of some kind - like the ones the Vikings used. The sails are down and tied, leaving the ship to the mercy of the elements. Waves hit the boat violently to and fro. I feel lost and afraid.

As I turn around, I am confronted by what looks like a 150 foot tall, grayish skinned lizard like being. This freakish entity looks like a giant frog but is much taller and butt ugly.

He has no eyes. Only empty sockets remain, giving him an even grislier appearance.

"You don't need eyes to see," he says to me angrily while shoving his fingertips into his sockets. "Look at me, I don't have eyes and I see you just fine. You don't need them either. Don't use your eyes to see!"

Not believing him, I argue that I do need my eyes to see, and that if I ever need some steroid pumped amphibian's advice in the future, I will ask for it. The frogman shakes his head, continuing to tell me that having physical eyes does not equate with having vision. I wake up from the dream feeling frustrated.

The Interpretation

Many times, whenever our energies and emotions are unbalanced, water will appear to us in a scary form. For myself, I was going through a taxing time where I found myself doubting my own instincts. Having been exposed to Catholic teachings from a young age, my first immersion into the free world of metaphysics and dream interpretation left me feeling as though I was betraying God.

The large lizard like being, in this case, was my own Spirit, telling me to rely on my own judgments as to what material to learn from rather than my upbringing's cultural taboos. He was also trying to teach me to rely on feelings rather than logic.

As for the eyes, this being was telling me to not use them, but to depend on another type of eye, third eye, to take me on journeys into Spirit.

The Sasquatch and the Strange House

In the center of my vision is a log house - or at least what looks like a log house. I cannot see anything too clearly. My vision is blurred at the edges, like how a professional photographer uses special effects to give his pictures a dreamy atmosphere. The house sits quietly in a grassy meadow.

Suddenly, the house door opens. Many people come screaming out in all directions. Curious as to why they seem so scared, I walk closer. Suddenly a large, hairy and muscular being comes tearing outside and running after the people. The creature spots me and makes a dead run towards my position. I am so shocked that I cannot move. I fall and pass out.

I awaken within my dream inside a yellowish room. I feel as if I am inside the house. But how, I wonder, I do not remember ever walking through a door to get in here. This is crazy! I am also amused to see myself naked and laid out flat on what appears to be a table of some kind. No straps

restrain me, and yet aside for my head, I cannot move a single muscle.

Lifting my head to look between my feet, I see a black, mug sized camera aperture mechanism straight ahead on the wall. Are they going to take a picture of my anus, I wonder? I would sure like to tell them about my more photogenic features instead. After all, who wants to be known as an asshole in other star systems?

A counter of some kind is off to my left. Objects are upon it. I cannot fully turn my head to see these in detail, so I just let it slide. Presences are then felt. Well, one presence actually, but it feels like more - like this being contains several beings inside itself. I cannot recall exactly what it is telling me, but I know it has to do with remembering, and the Earth's ecology and interdependency of species. So much information is coming in so fast (like data being uploaded from one computer to another) that all I can do is get out of thinking mode and allow my brain to

soak up this information for future use. Before I know it, the dream ends, and I wake up.

The Interpretation

To me, this dream was nothing less than a direct visit from Spirit - disguised by my conscious mind as a UFO abduction. Knowing how fearful I would be if confronted by a large, hairy creature like Bigfoot or Sasquatch, that is the form that Spirit decided to take on. I could only faint as it approached me.

I was not able to see past the mask.

Originally as Solar Spirits, we played a part in helping create our human bodies. We engineered all our various organs, limbs and members through the creative process of evolution. The manner in which we worked on these while in Spirit was like how a car mechanic interacts with the vehicle - they get their hands dirty by manipulating physical matter. In other words, once I found myself naked and lying down on that table and unable to move, I actually

became that car that my Spirit - my higher self - was looking at. This is why people often feel during abductions that there seems to be some sort of weird bond with these entities. Of course there is, since they are looking at themselves from themselves.

These visitations still make many people fearful. This leaves Spirit feeling sad for us, for it wants desperately to be accepted by us again. But to ensure that we are spiritually mature and brave enough first, Spirit still has to keep testing our courage by appearing scary.

The Owl and the Crystal Pyramid

The time of day feels like it is afternoon. The Sun shines brightly upon the land, and I am happy to be here. Suddenly, a movement is caught at my vision's edge. I turn to see a large brown owl flying across the landscape. The owl calls my name and tells me to follow it, so I do. We go across grassy meadows, more fields, and hillsides. Finally we come to an immense desert like plain, and in the center

of this plain stands a huge Pyramid nearly identical to the one in Egypt.

"Stay here and wait," the owl says. "You need to see what is going to happen."

Picking up speed, the owl silently glides towards the base of the Pyramid then quickly shoots up one of the slopes. It then passes the summit, slows down and stops in mid air and makes a power dive into the Pyramid. As the owl does this, the Pyramid changes from stone into a glasslike substance - like crystal. I somehow zoom in closer just in time to witness the owl turn translucent and gently land on what looks like a large glass chair. Because of its disproportionately large size in comparison to the owl, this chair actually looks more like a throne, like the kind royalty might use.

The owl has its backside to me and turns its head around my way in a smooth 180 degree motion. Its eyes are huge and transparent. The owl then says, "you're in my room now."

The dream ends and I reawake.

The Interpretation

Spirit can take on any form it wants, and in this case, in order to impart a teaching to this often unnecessarily stubborn individual (me), Spirit had to become a stereotyped image representing wisdom; hence, an owl. My emotions were up, as represented by the sunny day.

Actually, the whole scene seemed happy and rather intellectual. The gentle, rolling hills reminded me of the landscapes where I had spent my summers in Saskatchewan, Canada with my father. A comfortable thought. Traveling with the owl across the skies, we came to an object I had been thinking about for some time - the Pyramid. The transformation that the owl went through as it dove into the Pyramid from the top, symbolized to me how integrated it was to the structure.

Not long after, I learned from literary sources that inside the Great Pyramid are the King's and Queen's

chambers. I discover through the application of Chaldean Numerology that the mathematical ratios of the chamber's measures in volume and the numerological values of the words "King" and "Queen" are inverted. The ratios balance out. The male energy is double the female's in physical size, while hers is double the male's in Spirit. I also find out that the Great Pyramid resembles half of an octahedral crystal. This was why the Pyramid changed into crystal. A crystal and the Great Pyramid are actually the same thing. My feelings say, that this was what the owl was trying to get across to me.

The Twelve Hour Watch Piece

I am walking along a city sidewalk with old, large brick buildings all around me. On the other side of the street are three people wearing sunglasses. I cannot tell if they are male or female, though I get the feeling one is a man and the other two are women.

The man calls my name out loud and runs over to my side of the street. The two women stay on the sidewalk.

Not knowing who this stranger is, I run away. The stranger follows me into a back alley and is gaining ground fast. I spot a staircase ladder, leap up, and hoist myself onto it, thus leaving my pursuer behind on the ground. My joy is short lived. The stranger somehow commands the ladder to lower itself for him and it responds. Feeling scared, I continue racing up the stairwell and dive into an open window inside the building. Running down the narrow hallway, I spot two sofa chairs. I bring both of them together and set up a large wire snare trap between them. I look down the hallway and see the man coming towards me. He sees the trap awaiting him, smiles, and steps over it.

"Look," he says, "I'm not here to hurt you, so stop trying to run away. I only came here to teach you something."

Realizing his sincerity, I apologize about the trap. "I was only trying to defend myself," I tell him. We then find ourselves in a large old growth forest with mossy trees and a gargling brook running through it, rendering it the look of

a coastal forest. My newfound friend then disappears, leaving me holding a plate sized watch. As I look at each of the watch's twelve hours, the man's voice says that if I manage to become at one with each of these twelve hours, I will be able to communicate on a soul level with every tree, rock, body of water, plant, animal, and person around me. "The one contains the whole," he says. The dream ends.

The Interpretation

This time Spirit either joined up with two other entities (the women), or actually split itself threefold to show me my inner makeup. I do not know why I ran away from the stranger, as he did not physically threaten me in any way. Perhaps it was a reference to my usually being stubborn and always choosing the harder route.

Well, after unsuccessfully eluding my pursuer, I get the point that resisting is pointless. Giving up, I am finally eligible to be taught something. The old growth forest, being peaceful and serene, seemed like a great place to

meditate and learn of things. Notice how the water element, a small creek, was here again and provided gentle reassurance for my emotions. Looking at the watch that Spirit gave to me, eventually I came to learn that by assimilating all twelve Zodiac signs within one's character, symbolized by the hours, in one's character, one becomes more at one with all of Creation and the Universe. Indeed, I learned that gradually, every human being is becoming in full contact with Spirit and of a "thirteenth" sign - just like the world's masters.

A Lion in the White House

A large white, Victorian style house graces a huge theater stage. Behind the house shines a white light. This light is so bright that my vision is nearly blocked out. Gradually, the light behind the house dims and the house starts illuminating itself from within.

The door slowly opens and out walks an older but attractive blonde haired woman. She has two long braids, each one coming down the front of her torso. She appears

to be roughly fifty or fifty-five years of age and has a grandmother's demeanor. The woman steps up to the stage's edge and smiles at me in silence. She then motions me with her eyes to look back at the house, so I do.

Another carbon copy of the first woman - but younger, perhaps in her twenties or thirties - steps out of the house. This younger woman also steps up to the stage's edge and stops. Now both women look at me, smiling. Looking back to the house, I see the door open once again. A large, heavily muscled and magnificently maned lion appears. The beast casually glances around, yawns, and ambles over to where the women are, coming to a stop beside them. This lion is unusual, as its eyes seem almost human. They shine like bright flames. Neither of the women fear this lion. In fact, it is as if they are intimately involved with it somehow.

As all this unfolds before me, I look at these three beings and more particularly at the women. I feel as though I have to make a choice, but I cannot say what this choice is and why it has to be made. Two words flash across my

conscience, and these are "life", and "trouble". I then realize how much larger I am than these beings. I shrink myself down to their perspective and look from their vantage point. As I do this, I see a large "eye" hovering in mid air. "Ha - I was looking through this eye towards them", I say to myself. The dream ends.

The Interpretation

From the earliest of times, lions have symbolized power, ruler ship, and a savior element, the "lion" as referred to in scriptures. These are elements that everyone contains within. In this dream, two women combined together become the lion's bride.

For each of us, sometime during our lives we are going to run into that divine spark within ourselves (our own messiah potential), and we had better be prepared to handle the responsibility. For a man, what better challenge could Spirit throw than to make him decide between wisdom as

portrayed by the grandmother, and a carefree sex romp with a beautiful young maiden?

This type of challenge comes to us several times in our lifetimes, especially when we stand on the threshold of self realization and great accomplishments. It can also come via dreams or in actual real life circumstances. A teenaged nephew once told me about a dream he had like this, so it can come in at any age. All you can do is be spiritually prepared and choose wisely.

During the time this dream came to me, I had also been ruminating over the correlation between female and male energies inside the Great Pyramid and our original sexually androgynous bodies. Within each original human being, I was told by Spirit, was a male force and two female ones. For these two women to unite their sometimes conflicting natures, the male energy (lion) often had to put aside desire and choose wisdom in form of the older woman. If the choice was for sex with the younger one, at the

expense of learning a lesson from the elderly one, the end result between the two women would be a huge cat fight.

The Snake and the River

A fast flowing river dwells in a large forested gorge. "Thomas", a friend I had made in Virginia, is wading knee deep within it with me. We are fishing for rainbow trout. The river splits itself on either side of a big island. I see an old fisherman standing alone on the riverbank on the right hand side. He seems to blend in with the décor, watching us. After consulting one another as to which side of the island we should take, Thomas and I decide to split up and meet again further downstream. He winds up taking the left, I the right. As I wade my way down, the old man stands up and smiles at me. "Not much to catch where you're headed", he says. "Just a few minnows and that's it. Why don't you join your friend instead? There are better trophies where he's going."

Dismissing the old man's advice as a ploy to lure me away from a good fishing spot, I continue past him. Yes, I can be stubborn, but I am not proud of it.

As I enter the fork, I notice a doorless house half submerged in the river. I wade up to it and go inside. The water levels suddenly drop and soon no water is inside the house with me at all. Just a concrete floor. "Damn", I think to myself, "the old geezer was right. I should have gone with Thomas instead."

Looking back to the door, I see a three-foot long snake. Two very pretty women are teasing the snake by dancing around it, making it hyperactive.

As the snake sees me, it dashes madly for my legs. The reptile spirals up and around my body so fast that if I let it, I know it will fly right off the top of my head and through the ceiling. This scares me, so I grab the snake by the tail and try pulling it back down. The snake responds by delivering a quick bite to my wrist, making me let go. I feel

as though I just wasted precious time and that I should have went with Thomas instead. The dream ends.

The Interpretation

The Kundalini serpent is often present in dreams, and can be threatening or gentle. When this dream came to me, I was in Virginia sharing DREAMING THE PYRAMID in its oral and visual storytelling format with the cards. I was also learning how to channel my feeling sexually attracted to the women attending my sessions into more platonic relationships - an essential skill for any entertainer/storyteller to master. Because my spiritual focus was scattered at best, my Kundalini was acting up seemed ready to jolt up my body.

This fast paced emotional and spiritual growth probably correlates with the river's fast flow. As for the old fisherman on the bank, I suspect that this was Spirit trying to warn me of a potentially harmful path. Certainly, river detours could mean alternative, and not always productive, paths we

sometimes feel we have to follow anyhow - just to go through what we need to go through. Anytime a house comes into our dreams, take this to mean being faced with our own selves. In this case, my house (self) in the detour on the river gradually became drained of water. In other words, my emotional state of mind and soul was going down the drain - just because I wanted to go and have sex with people I did not even know.

A Parade of the Feminine

I am looking out onto a city street from three stories up inside an old building. The day is gray and threatens to rain. The trees are leafless - even though it looks like it is summertime. Sounds of heavy traffic roar in the air. Just another gray day in the big gray city.

Then a change is felt. Traffic sounds disappear. I look down the street in both directions to try finding out what has shifted. Other than the sudden absence of traffic noise, nothing stands out.

Then I see it.

Just around the corner across the street pops out a huge parade consisting entirely of singing, laughing, dancing women. Some are old and others are middle aged to teen aged. As this parade passes by, something beautiful happens. The trees start growing all their leaves back and the clouds start dissipating, leaving room for the Sun to shine through. Everything is bright and colorful.

But the most marvelous event is yet to pass.

As the women gleefully carry on, a massive downpour of whitish drops of fluid, to my eyes it looks like semen or light colored butter, occurs. Most of these stay suspended in mid air, gently bobbing up and down. Curious, I wave my arm through the air outside my window and my entire arm gets coated with this substance. The word Manna comes to mind. The women seem especially delighted with this downpour.

As the parade nears its end, I hear a grumbling in the distance. I chuckle when I see all the backed up traffic. Ironically, I feel that the cars are being driven by men.

"Guess they're looking forward for the parade to be over so they can get about their business," I say to myself. As the last of the women steps around the street corner and out of sight, I have a strong inner feeling telling me this is only the beginning of something new.

And I wake up.

The Interpretation

Within dreams it is common to see many houses, other souls, at once. Sometimes the amounts of people that dreams deal with are so huge that these become entire cities. So this dream appeared to be one dealing less with myself and more with the world in general.

We live in an era where male and female energies have become out of control. The Yin has nearly destroyed the Yang. The environment has suffered because of this spiritual imbalance. Young women only beginning to come to terms with their sexual powers are behaving in self destructive ways to try to become liked by young men. And

young men, still unaware of their true masculinity, treat women as mindless pleasure beasts rather than as equal companions.

The keepers of spiritual power within the Earth have always been the women.

Why?

Aside for the flexibility and more forgiving nature of women along with their greater intuitive abilities in general, nearly everything men have created and accomplished throughout history has been inspired by women. Whatever it is that women want, men are generally more than willing to provide or develop. If a society values material wealth, fame, status, and sensuous luxury, then that is what the society strives to achieve. Under this type of mindset, the natural world is always the loser. The first to feel this impact in the human world are our young people. They manifest this imbalance by indulging in harmful activities such as drugs, violent behavior, isolation, and apathy.

For the right kind of change to come about then, women around the world must continue to unite and support each other in their awakening to Spirit, as many are now doing with healing and talking circles. If women become spiritually strong, so will the men. Women are and will always be the spiritual backbone of the world.

As the feminine gets stronger within society, we will witness a balancing of the world's energies - a shift from our being mainly a patriarchy to an equal marriage with matriarchy. This will translate to our becoming a gentler, more holistic world, with greater environmental balance and understanding between people.

When will we know we are nearing this time? Life's barometers are the natural world and our young people. When we are able to drink directly from streams and rivers inside the biggest cities without becoming sick, when animals and plants become super abundant in the skies and forests and plains, and when young people start exhibiting

less despair, anger, fear, and aggression, we will know that the great spiritual purification is taking place.

Incidentally, once this occurs, sexually transmitted diseases will disappear and Man's "creative juices" will flow freely once again (like manna) between he and his partner. Not only will condoms and other inhibitors to sensual pleasure be a thing of the past, women will be able to mentally switch their fertility on and off.

#

My father has always been a gifted if somewhat reluctant mystic; he vividly remembers one dream in particular. It is one he had back in 1969. He has given me permission to share it here with you.

Dad's Dream

Dad is walking with a female cousin of his within a large grassy plain. They are surrounded by the voices of people singing on all sides. What they hear is neither symphonic nor orchestral in nature. Rather, the singing is composed of popular melodies, ones already familiar to most

people. To the south are the baritones and in the west are basses. Sopranos and altos in the form of women's voices lay to the north. The east also hosts a musical element, but its nature and purpose is new, unknown.

As they continue onward they come to a valley. Hundreds of yards away and imbedded within the ground in front of them sits a large and ancient mosaic made of colored marble. The pair begins walking towards it in order to investigate when the woman suddenly halts. She turns to face my father:

"I'm stopping here," she states, "I can't go on."

Continuing on alone, dad comes to a vantage point overlooking the valley. What he sees amazes him: three huge and magnificent Egyptian Pyramids loom in the distance. Glancing to his left, he sees a large open pit. In it are seven men dressed in suits with white shirts and dark ties. They look like businessmen. These men stare directly at him and proceed to hoist several large signs over their heads, each one displaying various geometrical shapes such

as circles, squares and rectangles. There are also astrological symbols and scores of mathematical equations and ratios such as Pi, The Golden Mean, and others. Once dad has been shown all that he needed to see, he begins to awaken.

The Interpretation

Dad has always felt that this dream was powerful and had special significance. The ancients believed that the Universe revolved around numbers and sound. Perhaps the singing in the four directions signifies truth within people's hearts all over the world and their common desire to express it by whatever means they have be it by music, art, science, literature, or philosophy.

The music coming from the east however is new and unfamiliar. The east represents birth. Perhaps this teaching from the east ties in with the many highly advanced souls possessing amazing scientific, artistic and healing abilities being born into the world. These souls have such strong awareness and sense of purpose in comparison to their

families that they often feel hopelessly alienated from them - and everyone else. They are wounded warriors searching for each other for support, friendship, and strength. I hope this book helps them find each other in whatever way it can.

And then there are the Pyramids. Why would a Native American man dream of them? Nothing seems to connect Egyptian Pyramids with my people - unless you spend a lot of time with Native elders and hear them speak of a time many thousands of years ago when our people used to live in the middle of the Atlantic and Pacific Oceans. People living in Atlantis and Lemuria possessed advanced spiritual and scientific knowledge, including magnificent architectural structures resembling Pyramids. Sadly, as most everyone knows, greed and corruption eventually caused these great civilizations to become destroyed from within and sink. Forever.

Assuming that the Native elders are right and that our people might have come from Atlantis, it only stands to reason that they would seek to continue trying to impart

their knowledge to future descendants, even trying to reach them through the dream state.

Perhaps these ancient ones also helped design and build the Pyramids in South America and Egypt. They would have banded together and put their collective wisdom into stone, trusting that future generations would eventually be able to decode it. The Great Pyramid would have been their crowning achievement.

My purpose here is to present the idea that the Great Pyramid of Egypt was built to represent us in our perfect and intended state. It gets its point across by using the sciences, art, spirituality, and philosophy. Can understanding the true nature of the Great Pyramid help us reverse the world's current chaotic state? Can it provide new insight into who we are and why we are here? I believe it can.

Of all the inquiries I have had over the years as an author and lecturer, one in particular comes up every time I

have finished speaking; people want to know where this information came from.

I invariably respond by saying that some of it came from reading books. Where necessary, I gave credit to these authors and their ideas. Some of the knowledge came from formulations devised on my own after having been exposed to traditional Native elder's stories and teachings. Most of it however, made its appearance through dreams or was simply deduced via logic and common sense. All I needed was to be pointed in the right direction. In this regard, to my eyes at least, Spirit has been of great help. I hope that what you have read here in these pages has helped you too.

RECOMMENDED READING

What follows is a list of works I have read over the years, ones that have helped me evolve spiritually and make sense of my dreams and visions. It is a precious gift indeed to be able to read a sentence or passage confirming what Native elders have mentioned or spoken of inside lodges or out on the land. In my case, in regards to refining my thoughts and ideas on previous civilizations such as Atlantis and Ancient Egypt, books have been of great importance.

#

RAINBOWS, SNOWFLAKES, AND QUARKS - PHYSICS AND

THE WORLD AROUND US, by Hans Christian Von Baeyer,

Random House, New York, 1984. ISBN 0-679-739-76-9

Any book by Linda Goodman.

CHEIRO'S BOOK OF NUMBERS, Cheiro, Simon and Schuster,

1993 (Reprint), ISBN 0131274414

THE SECRET TEACHINGS OF ALL AGES: An Encyclopedic

Outline of Masonic, Hermetic, Qabbalistic, and Rosicrucian

Symbolical Philosophy, Manly P. Hall, Philosophical Research

Society, 1978, ISBN 0893145483

FINDING THE THIRD EYE, Vera Stanley Alder, Samuel

Weiser, 1986, ISBN 0877280568

Any book on Edgar Cayce.

SASQUATCH: THE APES AMONG US, John Green, Ballantine

Books, 1978, ISBN 0888390181

BOOK OF THE HOPI, Frank Waters, Viking Press, 1985, ISBN

0140045279

EROTICA UNIVERSALIS, Gilles Neret, Tashen America Lic,

1996 ISBN 3822889636

THE BIBLE (Disregard all English versions other than King James. This version is the oldest one of the Holy Book in the English language and thus remains closest to the original teachings).

PYRAMID POWER: The Secret Energy of the Ancients

Revealed, Max Toth, Greg Nielson, 1990, ISBN 0892811064

SAVED BY THE LIGHT, Dannion Brinkley with Paul Perry,

Harper Collins, ISBN 0061008893

EMBRACED BY THE LIGHT, Betty J. Eadie & C. Taylor,

Bantam Books, ISBN 0553565915

BLACK ELK: The Sacred Ways of a Lakota, Wallace Black Elk

with William S. Lyon, 1991 (Reprint Edition) ISBN

0062500740